

## TREES

## Chapter-6



## 6.1 What is a Tree?

A *tree* is a data structure similar to a linked list but instead of each node pointing simply to the next node in a linear fashion, each node points to a number of nodes. Tree is an example of non-linear data structures. A *tree* structure is a way of representing the hierarchical nature of a structure in a graphical form.

In trees ADT (Abstract Data Type), order of the elements is not important. If we need ordering information linear data structures like linked lists, stacks, queues, etc. can be used.

## 6.2 Glossary

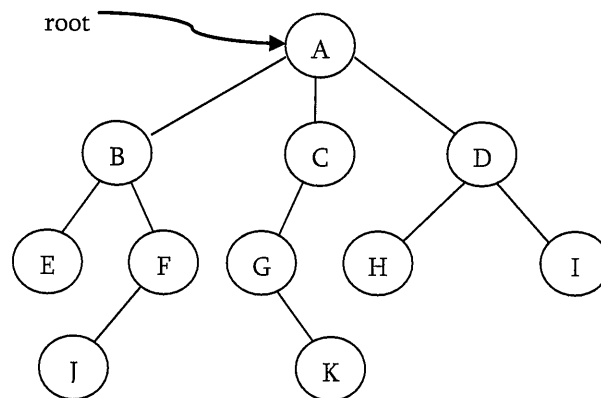

- The *root* of a tree is the node with no parents. There can be at most one root node in a tree (node *A* in the above example).
- An *edge* refers to the link from parent to child (all links in the figure).
- A node with no children is called *leaf* node (*E, J, K, H* and *I*).
- Children of same parent are called *siblings* (*B, C, D* are siblings of *A* and *E, F* are the siblings of *B*).
- A node *p* is an *ancestor* of a node *q* if there exists a path from root to *q* and *p* appears on the path. The node *q* is called a *descendant* of *p*. For example, *A, C* and *G* are the ancestors for *K*.
- Set of all nodes at a given depth is called *level* of the tree (*B, C* and *D* are same level). The root node is at level zero.

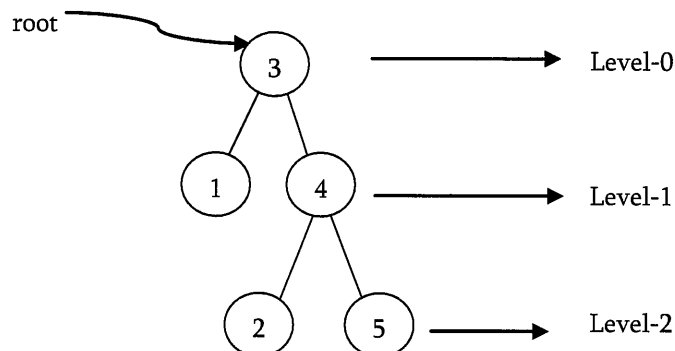

- The *depth* of a node is the length of the path from the root to the node (depth of *G* is 2, *A – C – G*).

- The *height* of a node is the length of the path from that node to the deepest node. The height of a tree is the length of the path from the root to the deepest node in the tree. A (rooted) tree with only one node (the root) has a height of zero. In the previous example, height of *B* is 2 ( $B - F - J$ ).
- *Height of the tree* is the maximum height among all the nodes in the tree and *depth of the tree* is the maximum depth among all the nodes in the tree. For a given tree depth and height returns the same value. But for individual nodes we may get different results.
- Size of a node is the number of descendants it has including itself (size of the subtree *C* is 3).
- If every node in a tree has only one child (except leaf nodes) then we call such trees as *skew trees*. If every node has only left child then we call them as *left skew trees*. Similarly, if every node has only right child then we call them as *right skew trees*.

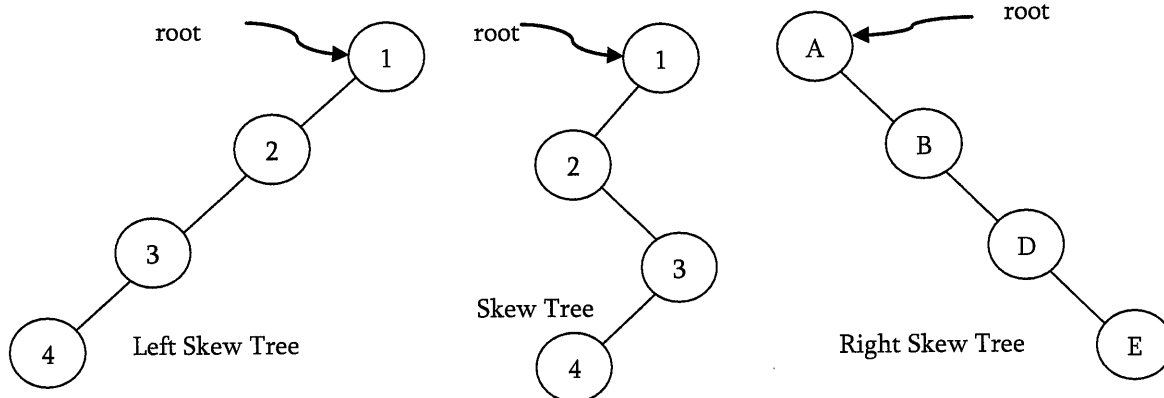

### 6.3 Binary Trees

A tree is called *binary tree* if each node has zero child, one child or two children. Empty tree is also a valid binary tree. We can visualize a binary tree as consisting of a root and two disjoint binary trees, called the left and right subtrees of the root.

#### Generic Binary Tree

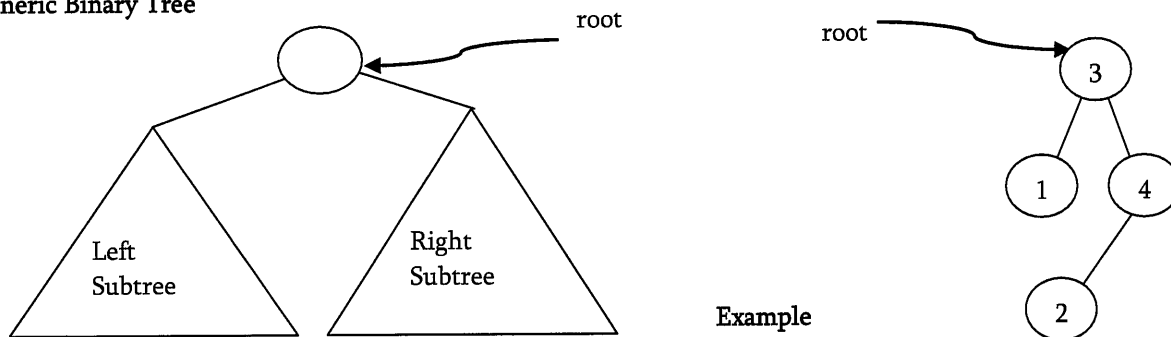

### 6.4 Types of Binary Trees

**Strict Binary Tree:** A binary tree is called *strict binary tree* if each node has exactly two children or no children.

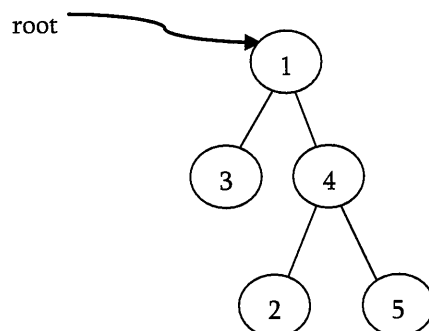

**Full Binary Tree:** A binary tree is called *full binary tree* if each node has exactly two children and all leaf nodes are at same level.

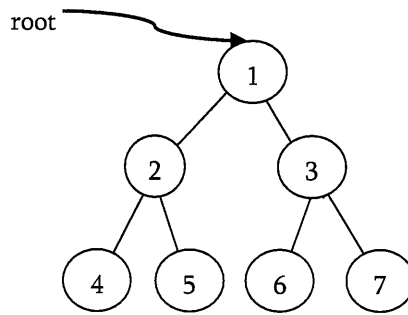

**Complete Binary Tree:** Before defining the *complete binary tree*, let us assume that the height of the binary tree is  $h$ . In complete binary trees, if we give numbering for the nodes by starting at root (let us say the root node has 1) then we get a complete sequence from 1 to number of nodes in the tree. While traversing we should give numbering for NULL pointers also. A binary tree is called complete binary tree if all leaf nodes are at height  $h$  or  $h - 1$  and also without any missing number in the sequence.

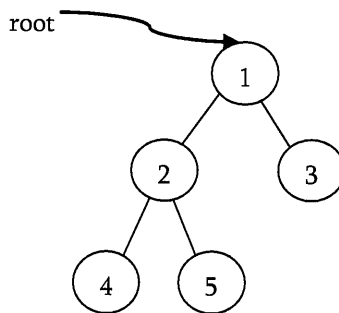

### 6.5 Properties of Binary Trees

For the following properties, let us assume that the height of the tree is  $h$ . Also, assume that root node is at height zero.

	Height	Number of nodes at level $h$
	$h = 0$	$2^0 = 1$
	$h = 1$	$2^1 = 2$
	$h = 2$	$2^2 = 4$

From the diagram we can infer the following properties:

- The number of nodes  $n$  in a full binary tree is  $2^{h+1} - 1$ . Since, there are  $h$  levels we need to add all nodes at each level [ $2^0 + 2^1 + 2^2 + \dots + 2^h = 2^{h+1} - 1$ ].
- The number of nodes  $n$  in a complete binary tree is between  $2^h$  (minimum) and  $2^{h+1} - 1$  (maximum). For more information on this, refer *Priority Queues* chapter.
- The number of leaf nodes in a full binary tree are  $2^h$ .
- The number of NULL links (wasted pointers) in a complete binary tree of  $n$  nodes are  $n + 1$ .

## Structure of Binary Trees

Now let us define structure of the binary tree. For simplicity, assume that the data of the nodes are integers. One way to represent a node (which contains the data) is to have two links which points to left and right children along with data fields as shown below:

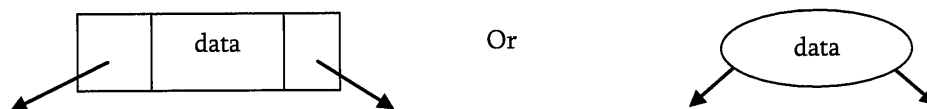

```
struct BinaryTreeNode {
    int data;
    struct BinaryTreeNode *left;
    struct BinaryTreeNode *right;
};
```

**Note:** In trees, the default flow is from parent to children and showing directed branches is not compulsory. For our discussion, we assume both the below representations are same.

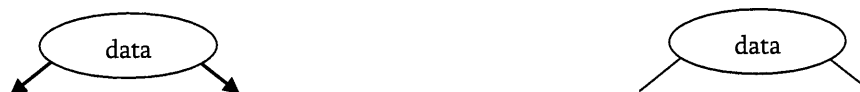

## Operations on Binary Trees

### Basic Operations

- Inserting an element in to a tree
- Deleting an element from a tree
- Searching for an element
- Traversing the tree

### Auxiliary Operations

- Finding size of the tree
- Finding the height of the tree
- Finding the level which has maximum sum
- Finding least common ancestor (LCA) for a given pair of nodes and many more.

## Applications of Binary Trees

Following are the some of the applications where *binary trees* play important role:

- Expression trees are used in compilers.
- Huffman coding trees which are used in data compression algorithms.
- Binary Search Tree (BST), which supports search, insertion and deletion on a collection of items in  $O(\log n)$  (average).
- Priority Queues (PQ), which supports search and deletion of minimum(or maximum) on a collection of items in logarithmic time (in worst case),

## 6.6 Binary Tree Traversals

In order to process trees, we need a mechanism for traversing them and that forms the subject of this section. The process of visiting all nodes of a tree is called *tree traversal*. Each of the nodes is processed only once but they may be visited more than once. As we have already seen that in linear data structures (like linked lists, stacks, queues, etc...), the elements are visited in sequential order. But, in tree structures there are many different ways.

Tree traversal is like searching the tree except that in traversal the goal is to move through the tree in some particular order. In addition, all nodes are processed in the traversal but searching stops when the required node is found.

### Traversal Possibilities

Starting at the root of a binary tree, there are three main steps that can be performed and the order in which they are performed defines the traversal type. These steps are: performing an action on the current node (referred to as "visiting" the node and denotes with "D"), traversing to the left child node (denotes with "L"), and traversing to the right child node (denotes with "R"). This process can be easily described through recursion. Based on the above definition there are 6 possibilities:

1. *LDR*: Process left subtree, process the current node data and then process right subtree
2. *LRD*: Process left subtree, process right subtree and then process the current node data
3. *DLR*: Process the current node data, process left subtree and then process right subtree
4. *DRL*: Process the current node data, process right subtree and then process left subtree
5. *RDL*: Process right subtree, process the current node data and then process left subtree
6. *RLD*: Process right subtree, process left subtree and then process the current node data

### Classifying the Traversals

The sequence in which these entities processed defines a particular traversal method. The classification based on the order in which current node is processed. That means, if we are classifying based on current node (*D*) and if *D* comes in the middle then it does not matter whether *L* on left side of *D* or *R* is on left side of *D*. Similarly, it does not matter whether *L* is on right side of *D* or *R* is on right side of *D*. Due to this, the total 6 possibilities were reduced to 3 and they are:

- Preorder (*DLR*) Traversal
- Inorder (*LDR*) Traversal
- Postorder (*LRD*) Traversal

There is another traversal method which does not depend on above orders and it is:

- Level Order Traversal: This method is inspired from Breadth First Traversal (BFS of Graph algorithms).

Let us use the below diagram for remaining discussion.

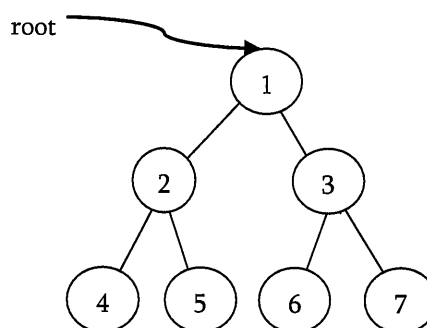

### PreOrder Traversal

In pre-order traversal, each node is processed before (pre) either of its sub-trees. This is the simplest traversal to understand. However, even though each node is processed before the subtrees, it still requires that some information

must be maintained while moving down the tree. In the example above, the 1 is processed first, then the left sub-tree followed by the right subtree. Therefore, processing must return to the right sub-tree after finishing the processing of the left subtree. To move to right subtree after processing left subtree, we must maintain the root information. The obvious ADT for such information is a stack. Because of its LIFO structure, it is possible to get the information about the right subtrees back in the reverse order.

Preorder traversal is defined as follows:

- Visit the root.
- Traverse the left subtree in Preorder.
- Traverse the right subtree in Preorder.

The nodes of tree would be visited in the order: 1 2 4 5 3 6 7

```
void PreOrder(struct BinaryTreeNode *root){
    if(root) {
        printf("%d",root->data);
        PreOrder(root->left);
        PreOrder (root->right);
    }
}
```

Time Complexity:  $O(n)$ . Space Complexity:  $O(n)$ .

### Non-Recursive Preorder Traversal

In recursive version a stack is required as we need to remember the current node so that after completing the left subtree we can go to right subtree. To simulate the same, first we process the current node and before going to left subtree, we store the current node on stack. After completing the left subtree processing, *pop* the element and go to its right subtree. Continue this process until stack is nonempty.

```
void PreOrderNonRecursive(struct BinaryTreeNode *root){
    struct Stack *S = CreateStack();
    while(1) {
        while(root) {
            //Process current node
            printf("%d",root->data);
            Push(S,root);
            //If left subtree exists, add to stack
            root = root->left;
        }
        if(IsEmptyStack(S))
            break;
        root = Pop(S);
        //Indicates completion of left subtree and current node, now go to right subtree
        root = root->right;
    }
    DeleteStack(S);
}
```

Time Complexity:  $O(n)$ . Space Complexity:  $O(n)$ .

### InOrder Traversal

In Inorder traversal the root is visited between the subtrees. Inorder traversal is defined as follows:

- Traverse the left subtree in Inorder.
- Visit the root.

- Traverse the right subtree in Inorder.

The nodes of tree would be visited in the order: 4 2 5 1 6 3 7

```
void InOrder(struct BinaryTreeNode *root){
    if(root) {
        InOrder(root->left);
        printf("%d",root->data);
        InOrder(root->right);
    }
}
```

Time Complexity:  $O(n)$ . Space Complexity:  $O(n)$ .

### Non-Recursive Inorder Traversal

Non-recursive version of Inorder traversal is very much similar to Preorder. The only change is, instead of processing the node before going to left subtree, process it after popping (which indicates after completion of left subtree processing).

```
void InOrderNonRecursive(struct BinaryTreeNode *root){
    struct Stack *S = CreateStack();
    while(1) {
        while(root) {
            Push(S,root);
            //Got left subtree and keep on adding to stack
            root = root->left;
        }
        if(IsEmptyStack(S))
            break;
        root = Pop(S);
        printf("%d", root->data);          //After popping, process the current node
        //Indicates completion of left subtree and current node, now go to right subtree
        root = root->right;
    }
    DeleteStack(S);
}
```

Time Complexity:  $O(n)$ . Space Complexity:  $O(n)$ .

### PostOrder Traversal

In postorder traversal, the root is visited after both subtrees. Postorder traversal is defined as follows:

- Traverse the left subtree in Postorder.
- Traverse the right subtree in Postorder.
- Visit the root.

The nodes of tree would be visited in the order: 4 5 2 6 7 3 1

```
void PostOrder(struct BinaryTreeNode *root){
    if(root) {
        PostOrder(root->left);
        PostOrder(root->right);
        printf("%d",root->data);
    }
}
```

Time Complexity:  $O(n)$ . Space Complexity:  $O(n)$ .

### Non-Recursive Postorder Traversal

In preorder and inorder traversals, after popping the stack element we do not need to visit the same vertex again. But in postorder traversal, each node is visited twice. That means, after processing left subtree we will be visiting the current node and also after processing the right subtree we will be visiting the same current node. But we should be processing the node during the second visit. Here the problem is how to differentiate whether we are returning from left subtree or right subtree?

Trick for this problem is: after popping an element from stack, check whether that element and right of top of the stack are same or not. If they are same then we are done with processing of left subtree and right subtree. In this case we just need to pop the stack one more time and print its data.

```
void PostOrderNonRecursive(struct BinaryTreeNode *root){
    struct Stack *S = CreateStack();
    while (1) {
        if (root) {
            Push(S,root);
            root=root->left;
        }
        else {
            if(IsEmptyStack(S)) {
                printf("Stack is Empty");
                return;
            }
            else if(Top(S)->right == NULL) {
                root = Pop(S);
                printf("%d",root->data);
                if(root == Top(S)->right) {
                    printf("%d",Top(S)->data);
                    Pop(S);
                }
            }
            if(!IsEmptyStack(S))
                root=Top(S)->right;
            else
                root=NULL;
        }
    }
    DeleteStack(S);
}
```

Time Complexity:  $O(n)$ . Space Complexity:  $O(n)$ .

### Level Order Traversal

Level order traversal is defined as follows:

- Visit the root.
- While traversing level  $l$ , keep all the elements at level  $l + 1$  in queue.
- Go to the next level and visit all the nodes at that level.
- Repeat this until all levels are completed.

The nodes of tree would be visited in the order: 1 2 3 4 5 6 7

```
void LevelOrder(struct BinaryTreeNode *root){
    struct BinaryTreeNode *temp;
```



```

struct Queue *Q = CreateQueue();
if(!root)
    return;
EnQueue(Q,root);
while(!IsEmptyQueue(Q)) {
    temp = DeQueue(Q);
    //Process current node
    printf("%d", temp->data);
    if(temp->left)
        EnQueue(Q, temp->left);
    if(temp->right)
        EnQueue(Q, temp->right);
}
DeleteQueue(Q);
}

```

Time Complexity:  $O(n)$ . Space Complexity:  $O(n)$ . Since, in the worst case, all the nodes on the entire last level could be in the queue simultaneously.

## Problems on Binary Trees

**Problem-1** Give an algorithm for finding maximum element in binary tree.

**Solution:** One simple way of solving this problem is: find the maximum element in left subtree, find maximum element in right sub tree, compare them with root data and select the one which is giving the maximum value. This approach can be easily implemented with recursion.

```

int FindMax(struct BinaryTreeNode *root) {
    int root_val, left, right, max = INT_MIN;
    if(root !=NULL) {
        root_val = root->data;
        left = FindMax(root->left);
        right = FindMax(root->right);

        // Find the largest of the three values.
        if(left > right)
            max = left;
        else
            max = right;
        if(root_val > max)
            max = root_val;
    }
    return max;
}

```

Time Complexity:  $O(n)$ . Space Complexity:  $O(n)$ .

**Problem-2** Give an algorithm for finding maximum element in binary tree without recursion.

**Solution:** Using level order traversal: just observe the elements data while deleting.

```

int FindMaxUsingLevelOrder(struct BinaryTreeNode *root){
    struct BinaryTreeNode *temp;
    int max = INT_MIN;
    struct Queue *Q = CreateQueue();
    EnQueue(Q,root);
}

```

```

while(!IsEmptyQueue(Q)) {
    temp = DeQueue(Q);
    // largest of the three values
    if(max < temp->data)
        max = temp->data;
    if(temp->left)
        EnQueue (Q, temp->left);
    if(temp->right)
        EnQueue (Q, temp->right);
}
DeleteQueue(Q);
return max;
}

```

Time Complexity:  $O(n)$ . Space Complexity:  $O(n)$ .

**Problem-3** Give an algorithm for searching an element in binary tree.

**Solution:** Given a binary tree, return true if a node with the data is found in the tree. Recurse down the tree, choose the left or right branch by comparing the data with each nodes data.

```

int FindInBinaryTreeUsingRecursion(struct BinaryTreeNode *root, int data) {
    int temp;
    // Base case == empty tree, in that case, the data is not found so return false
    if(root == NULL)
        return 0;
    else { //see if found here
        if(data == root->data)
            return 1;
        else { // otherwise recur down the correct subtree
            temp = FindInBinaryTreeUsingRecursion (root->left, data)
            if(temp != 0)
                return temp;
            else return(FindInBinaryTreeUsingRecursion(root->right, data));
        }
    }
    return 0;
}

```

Time Complexity:  $O(n)$ . Space Complexity:  $O(n)$ .

**Problem-4** Give an algorithm for searching an element in binary tree without recursion.

**Solution:** We can use level order traversal for solving this problem. The only change required in level order traversal is, instead of printing the data we just need to check whether the root data is equal to the element we want to search.

```

int SearchUsingLevelOrder(struct BinaryTreeNode *root, int data){
    struct BinaryTreeNode *temp;
    struct Queue *Q;
    if(!root)
        return -1;
    Q = CreateQueue();
    EnQueue(Q,root);
    while(!IsEmptyQueue(Q)) {
        temp = DeQueue(Q);

```

```

        //see if found here
        if(data == root->data)
            return 1;
        if(temp->left)
            EnQueue (Q, temp->left);
        if(temp->right)
            EnQueue (Q, temp->right);
    }
    DeleteQueue(Q);
    return 0;
}

```

Time Complexity:  $O(n)$ . Space Complexity:  $O(n)$ .

**Problem-5** Give an algorithm for inserting an element into binary tree.

**Solution:** Since the given tree is a binary tree, we can insert the element wherever we want. To insert an element, we can use the level order traversal and insert the element wherever we found the node whose left or right child is NULL.

```

void InsertInBinaryTree(struct BinaryTreeNode *root, int data){
    struct Queue *Q;
    struct BinaryTreeNode *temp;
    struct BinaryTreeNode *newNode;
    newNode = (struct BinaryTreeNode *) malloc(sizeof(struct BinaryTreeNode));
    newNode->left = newNode->right = NULL;
    if(!newNode) {
        printf("Memory Error");
        return;
    }
    if(!root) {
        root = newNode;
        return;
    }
    Q = CreateQueue();
    EnQueue(Q,root);
    while(!IsEmptyQueue(Q)) {
        temp = DeQueue(Q);
        if(temp->left)
            EnQueue(Q, temp->left);
        else {
            temp->left=newNode;
            DeleteQueue(Q);
            return;
        }
        if(temp->right)
            EnQueue(Q, temp->right);
        else {
            temp->right=newNode;
            DeleteQueue(Q);
            return;
        }
    }
    DeleteQueue(Q);
}

```

Time Complexity:  $O(n)$ . Space Complexity:  $O(n)$ .

**Problem-6** Give an algorithm for finding the size of binary tree.

**Solution:** Calculate the size of left and right subtrees recursively, add 1 (current node) and return to its parent.

// Compute the number of nodes in a tree.

```
int SizeOfBinaryTree(struct BinaryTreeNode *root) {
    if(root==NULL)
        return 0;
    else
        return(SizeOfBinaryTree(root->left) + 1 + SizeOfBinaryTree(root->right));
}
```

Time Complexity:  $O(n)$ . Space Complexity:  $O(n)$ .

**Problem-7** Can we solve the Problem-6 without recursion?

**Solution:** Yes, using level order traversal.

```
int SizeofBTUsingLevelOrder(struct BinaryTreeNode *root){
    struct BinaryTreeNode *temp;
    struct Queue *Q;
    int count = 0;
    if(!root) return 0;
    Q = CreateQueue();
    EnQueue(Q,root);
    while(!IsEmptyQueue(Q)) {
        temp = DeQueue(Q);
        count++;
        if(temp->left)
            EnQueue (Q, temp->left);
        if(temp->right)
            EnQueue (Q, temp->right);
    }
    DeleteQueue(Q);
    return count;
}
```

Time Complexity:  $O(n)$ . Space Complexity:  $O(n)$ .

**Problem-8** Give an algorithm for printing the level order data in reverse order. For example, the output for the below tree should be: 4 5 6 7 2 3 1

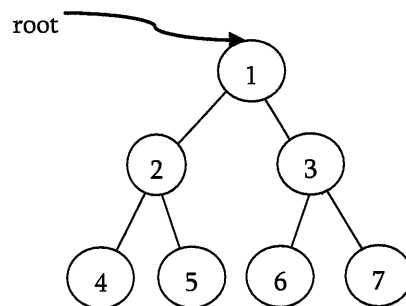

**Solution:**

```
void LevelOrderTraversalInReverse(struct BinaryTreeNode *root){
    struct Queue *Q;
    struct Stack *s = CreateStack();
    struct BinaryTreeNode *temp;
    if(!root) return;
    Q = CreateQueue();
    EnQueue(Q, root);
```

```

while(!IsEmptyQueue(Q)) {
    temp = DeQueue(Q);
    if(temp->right)
        EnQueue(Q, temp->right);
    if(temp->left)
        EnQueue(Q, temp->left);
    Push(s, temp);
}
while(!IsEmptyStack(s))
    printf("%d", Pop(s)->data);
}

```

Time Complexity:  $O(n)$ . Space Complexity:  $O(n)$ .

**Problem-9** Give an algorithm for deleting the tree.

**Solution:** To delete a tree we must traverse all the nodes of the tree and delete them one by one. So which traversal we should use Inorder, Preorder, Postorder or Level order Traversal?

Before deleting the parent node we should delete its children nodes first. We can use postorder traversal as it does the work without storing anything. We can delete tree with other traversals also with extra space complexity. For the following tree nodes are deleted in order – 4, 5, 2, 3, 1.

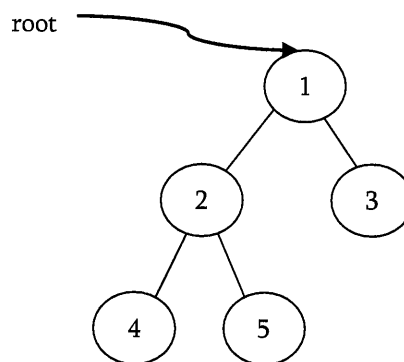

```

void DeleteBinaryTree(struct BinaryTreeNode *root){
    if(root == NULL)
        return;
    /* first delete both subtrees */
    DeleteBinaryTree(root->left);
    DeleteBinaryTree(root->right);
    //Delete current node only after deleting subtrees
    free(root);
}

```

Time Complexity:  $O(n)$ . Space Complexity:  $O(n)$ .

**Problem-10** Give an algorithm for finding the height (or depth) of the binary tree.

**Solution:** Recursively calculate height of left and right subtrees of a node and assign height to the node as max of the heights of two children plus 1. This is similar to *PreOrder* tree traversal (and *DFS* of Graph algorithms).

```

int HeightOfBinaryTree(struct BinaryTreeNode *root){
    int leftheight, rightheight;
    if(root == NULL)
        return 0;
    else { /* compute the depth of each subtree */

```

```

        leftheight = HeightOfBinaryTree(root→left);
        rightheight = HeightOfBinaryTree(root→right);
        if(leftheight > rightheight)
            return(leftheight + 1);
        else    return(rightheight + 1);
    }
}

```

Time Complexity:  $O(n)$ . Space Complexity:  $O(n)$ .

**Problem-11** Can we solve the Problem-10 without recursion?

**Solution:** Yes. Using level order traversal. This is similar to *BFS* of Graph algorithms. End of level is identified with NULL.

```

int FindHeightofBinaryTree(struct BinaryTreeNode *root){
    int level=1;
    struct Queue *Q;
    if(!root) return 0;
    Q = CreateQueue();
    EnQueue(Q,root);
    // End of first level
    EnQueue(Q,NULL);
    while(!IsEmptyQueue(Q)) {
        root=DeQueue(Q);
        // Completion of current level.
        if(root==NULL) {
            //Put another marker for next level.
            if(!IsEmptyQueue(Q))
                EnQueue(Q,NULL);
            level++;
        }
        else { if(root→left)
                EnQueue(Q, root→left);
                if(root→right)
                    EnQueue(Q, root→right);
            }
        }
    return level;
}

```

Time Complexity:  $O(n)$ . Space Complexity:  $O(n)$ .

**Problem-12** Give an algorithm for finding the deepest node of the binary tree.

**Solution:**

```

struct BinaryTreeNode *DeepestNodeinBinaryTree(struct BinaryTreeNode *root){
    struct BinaryTreeNode *temp;
    struct Queue *Q;
    if(!root) return NULL;
    Q = CreateQueue();
    EnQueue(Q,root);
    while(!IsEmptyQueue(Q)) {
        temp = DeQueue(Q);
        if(temp→left)

```

```

        EnQueue(Q, temp→left);
    if(temp→right)
        EnQueue(Q, temp→right);
    }
    DeleteQueue(Q);
    return temp;
}

```

Time Complexity:  $O(n)$ . Space Complexity:  $O(n)$ .

**Problem-13** Give an algorithm for deleting an element from binary tree.

**Solution:** The deletion of a node in binary tree can be implemented as

- Find the node which we want to delete.
- Find the deepest node in the tree.
- Replace the deepest nodes data with node to be deleted.
- Then delete the deepest node.

**Problem-14** Give an algorithm for finding the number of leaves in the binary tree without using recursion.

**Solution:** The set of all nodes whose both left and either right are NULL are called leaf nodes.

```

void NumberOfLeavesInBTusingLevelOrder(struct BinaryTreeNode *root){
    struct BinaryTreeNode *temp;
    struct Queue *Q;
    int count = 0;
    if(!root) return 0;
    Q = CreateQueue();
    EnQueue(Q,root);
    while(!IsEmptyQueue(Q)) {
        temp = DeQueue(Q);
        if(!temp→left && !temp→right)
            count++;
        else {
            if(temp→left)
                EnQueue(Q, temp→left);
            if(temp→right)
                EnQueue(Q, temp→right);
        }
    }
    DeleteQueue(Q);
    return count;
}

```

Time Complexity:  $O(n)$ . Space Complexity:  $O(n)$ .

**Problem-15** Give an algorithm for finding the number of full nodes in the binary tree without using recursion.

**Solution:** The set of all nodes with both left and right children are called full nodes.

```

void NumberOfFullNodesInBTusingLevelOrder(struct BinaryTreeNode *root){
    struct BinaryTreeNode *temp;
    struct Queue *Q;
    int count = 0;
    if(!root) return 0;
    Q = CreateQueue();
    EnQueue(Q,root);
    while(!IsEmptyQueue(Q)) {

```

```

        temp = DeQueue(Q);
        if(temp->left && temp->right)
            count++;
        if(temp->left)
            EnQueue (Q, temp->left);
        if(temp->right)
            EnQueue (Q, temp->right);
    }
    DeleteQueue(Q);
    return count;
}

```

Time Complexity:  $O(n)$ . Space Complexity:  $O(n)$ .

**Problem-16** Give an algorithm for finding the number of half nodes (nodes with only one child) in the binary tree without using recursion.

**Solution:** The set of all nodes with either left or either right child (but not both) are called half nodes.

```

void NumberOfHalfNodesInBTusingLevelOrder(struct BinaryTreeNode *root){
    struct BinaryTreeNode *temp;
    struct Queue *Q;
    int count = 0;
    if(!root)
        return 0;
    Q = CreateQueue();
    EnQueue(Q,root);
    while(!IsEmptyQueue(Q)) {
        temp = DeQueue(Q);
        //we can use this condition also instead of two temp->left ^ temp->right
        if(!temp->left && temp->right || temp->left && !temp->right)
            count++;
        if(temp->left)
            EnQueue (Q, temp->left);
        if(temp->right)
            EnQueue (Q, temp->right);
    }
    DeleteQueue(Q);
    return count;
}

```

Time Complexity:  $O(n)$ . Space Complexity:  $O(n)$ .

**Problem-17** Given two binary trees, return true if they are structurally identical.

**Solution:**

**Algorithm:**

- If both trees are NULL then return true.
- If both trees are not NULL, then compare data and recursively check left and right subtree structures.

```

//Return true if they are structurally identical.
int AreStructurallySameTrees(struct BinaryTreeNode *root1, struct BinaryTreeNode *root2) {
    // both empty->1
    if(root1==NULL && root2==NULL)
        return 1;
    if(root1==NULL || root2==NULL)

```



```

    return 0;
    // both non-empty→compare them
    return(root1→data == root2→data && AreStructurullySameTrees(root1→left, root2→left) &&
        AreStructurullySameTrees(root1→right, root2→right));
}

```

Time Complexity:  $O(n)$ . Space Complexity:  $O(n)$ , for recursive stack.

**Problem-18** Give an algorithm for finding the diameter of the binary tree. The diameter of a tree (sometimes called the *width*) is the number of nodes on the longest path between two leaves in the tree.

**Solution:** To find the diameter of a tree, first calculate the diameter of left subtree and right sub trees recursively. Among these two values, we need to send maximum along with current level (+1).

```

int DiameterOfTree(struct BinaryTreeNode *root, int *ptr){
    int left, right;
    if(!root)
        return 0;
    left = DiameterOfTree(root→left, ptr);
    right = DiameterOfTree(root→right, ptr);
    if(left + right > *ptr)
        *ptr = left + right;
    return Max(left, right)+1;
}

```

Time Complexity:  $O(n)$ . Space Complexity:  $O(n)$ .

**Problem-19** Give an algorithm for finding the level which is having maximum sum in the binary tree.

**Solution:** The logic is very much similar to finding number of levels. The only change is, we need to keep track of sums as well.

```

int FindLevelwithMaxSum(struct BinaryTreeNode *root){
    struct BinaryTreeNode *temp;
    int level=0, maxLevel=0;
    struct Queue *Q;
    int currentSum = 0, maxSum = 0;
    if(!root) return 0;
    Q=CreateQueue();
    EnQueue(Q,root);
    EnQueue(Q,NULL); //End of first level.
    while(!IsEmptyQueue(Q) {
        temp =DeQueue(Q);
        // If the current level is completed then compare sums
        if(temp == NULL) {
            if(currentSum > maxSum) {
                maxSum = currentSum;
                maxLevel = level;
            }
            currentSum = 0;
            //place the indicator for end of next level at the end of queue
            if(!IsEmptyQueue(Q))
                EnQueue(Q,NULL);
            level++;
        }
    }
}

```

```

        else { currentSum += temp->data;
              if(temp->left)
                  EnQueue(temp, temp->left);
              if(temp->right)
                  EnQueue(temp, temp->right);
            }
        }
    }
    return maxLevel;
}

```

Time Complexity:  $O(n)$ . Space Complexity:  $O(n)$ .

**Problem-20** Given a binary tree, print out all of its root-to-leaf paths.

**Solution:** Refer comments in functions.

```

void PrintPathsRecur(struct BinaryTreeNode *root, int path[], int pathLen) {
    if(root == NULL)
        return;
    // append this node to the path array
    path[pathLen] = root->data;
    pathLen++;
    // it's a leaf, so print the path that led to here
    if(root->left == NULL && root->right == NULL)
        PrintArray(path, pathLen);
    else { // otherwise try both subtrees
        PrintPathsRecur(root->left, path, pathLen);
        PrintPathsRecur(root->right, path, pathLen);
    }
}

// Function that prints out an array on a line.
void PrintArray(int ints[], int len) {
    for (int i=0; i<len; i++)
        printf("%d",ints[i]);
}

```

Time Complexity:  $O(n)$ . Space Complexity:  $O(n)$ , for recursive stack.

**Problem-21** Give an algorithm for checking the existence of path with given sum. That means, given a sum check whether there exists a path from root to any of the nodes.

**Solution:** For this problem, the strategy is: subtract the node value from the sum before calling its children recursively, and check to see if the sum is 0 when we run out of tree.

```

int HasPathSum(struct BinaryTreeNode * root, int sum) {
    // return true if we run out of tree and sum==0
    if(root == NULL) return(sum == 0);
    else { // otherwise check both subtrees
        int remainingSum = sum - root->data;
        if((root->left && root->right) || (!root->left && !root->right))
            return(HasPathSum(root->left, remainingSum) || HasPathSum(root->right, remainingSum));
        else if(root->left)
            return HasPathSum(root->left, remainingSum);
        else
            return HasPathSum(root->right, remainingSum);
    }
}

```

}

Time Complexity:  $O(n)$ . Space Complexity:  $O(n)$ .**Problem-22** Give an algorithm for finding the sum of all elements in binary tree.**Solution:** Recursively, call left subtree sum, right subtree sum and add their values to current nodes data.

```
int Add(struct BinaryTreeNode *root) {
    if(root == NULL) return 0;
    else return (root->data + Add(root->left) + Add(root->right));
}
```

Time Complexity:  $O(n)$ . Space Complexity:  $O(n)$ .**Problem-23** Can we solve Problem-22 without recursion?**Solution:** We can use level order traversal with simple change. Every time after deleting an element from queue, add the nodes data value to *sum* variable.

```
int SumofBTusingLevelOrder(struct BinaryTreeNode *root){
    struct BinaryTreeNode *temp;
    struct Queue *Q;
    int sum = 0;
    if(!root) return 0;
    Q = CreateQueue();
    EnQueue(Q,root);
    while(!IsEmptyQueue(Q)) {
        temp = DeQueue(Q);
        sum += temp->data;
        if(temp->left)
            EnQueue (Q, temp->left);
        if(temp->right)
            EnQueue (Q, temp->right);
    }
    DeleteQueue(Q);
    return sum;
}
```

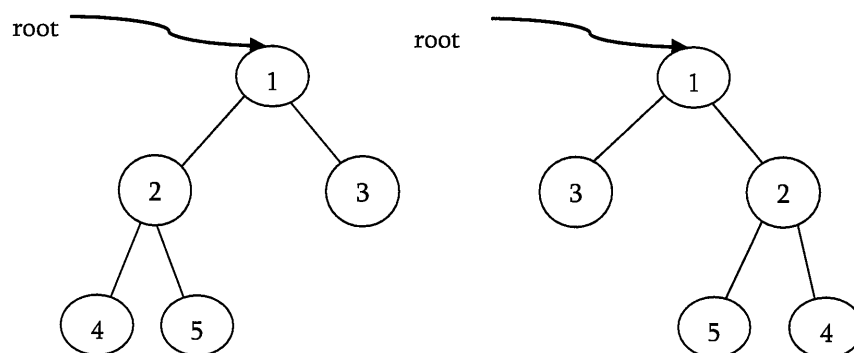
Time Complexity:  $O(n)$ . Space Complexity:  $O(n)$ .**Problem-24** Give an algorithm for converting a tree to its mirror. Mirror of a tree is another tree with left and right children of all non-leaf nodes interchanged.**Solution:**

```
struct BinaryTreeNode *MirrorOfBinaryTree(struct BinaryTreeNode *root){
    struct BinaryTreeNode * temp;
    if(root) {
```

```

    MirrorOfBinaryTree(root→left);
    MirrorOfBinaryTree(root→right);
    /* swap the pointers in this node */
    temp = root→left;
    root→left = root→right;
    root→right = temp;
}
return root;
}

```

Time Complexity:  $O(n)$ . Space Complexity:  $O(n)$ .

**Problem-25** Given two trees, give an algorithm for checking whether they are mirrors of each other.

**Solution:**

```

int AreMirrors(struct BinaryTreeNode * root1, struct BinaryTreeNode * root2) {
    if(root1 == NULL && root2 == NULL)    return 1;
    if(root1 == NULL || root2 == NULL) return 0;
    if(root1→data != root2→data)    return 0;
    else return AreMirrors(root1→left, root2→right) && AreMirrors(root1→right, root2→left);
}

```

Time Complexity:  $O(n)$ . Space Complexity:  $O(n)$ .

**Problem-26** Give an algorithm for finding LCA (Least Common Ancestor) of two nodes in a Binary Tree.

**Solution:**

```

struct BinaryTreeNode *LCA(struct BinaryTreeNode *root, struct BinaryTreeNode *α, struct BinaryTreeNode *β){
    struct BinaryTreeNode *left, *right;
    if(root == NULL) return root;
    if(root == α || root == β) return root;
    left = LCA (root→left, α, β );
    right = LCA (root→right, α, β );
    if(left && right)
        return root;
    else    return (left? left: right)
}

```

Time Complexity:  $O(n)$ . Space Complexity:  $O(n)$  for recursion.

**Problem-27** Give an algorithm for constructing binary tree from given Inorder and Preorder traversals.

**Solution:** Let us consider the below traversals:

Inorder sequence: D B E A F C

Preorder sequence: A B D E C F

In a Preorder sequence, leftmost element denotes the root of the tree. So we know 'A' is root for given sequences. By searching 'A' in Inorder sequence we can find out all elements on left side of 'A' which come under left subtree and elements right side of 'A' which come under right subtree. So we get the below structure.

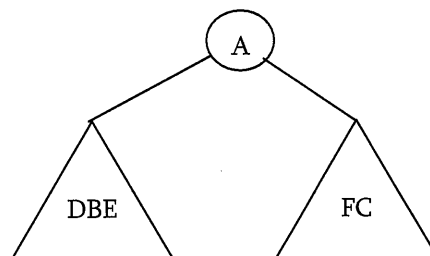

We recursively follow above steps and get the following tree.

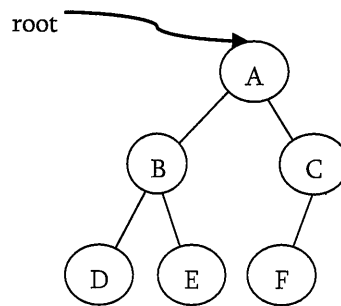

**Algorithm:** BuildTree()

- 1 Select an element from Preorder. Increment a Preorder index variable (preIndex in below code) to pick next element in next recursive call.
- 2 Create a new tree node (newNode) with the data as selected element.
- 3 Find the selected elements index in Inorder. Let the index be inIndex.
- 4 Call BuildBinaryTree for elements before inIndex and make the built tree as left subtree of newNode.
- 5 Call BuildBinaryTree for elements after inIndex and make the built tree as right subtree of newNode.
- 6 return newNode.

```

struct BinaryTreeNode * BuildBinaryTree(int inOrder[], int preOrder[], int inStrt, int inEnd){
    static int preIndex = 0;
    struct BinaryTreeNode *newNode
    if(inStrt > inEnd) return NULL;
    newNode = (struct BinaryTreeNode *) malloc (sizeof(struct BinaryTreeNode));
    if(!newNode) {
        printf("Memory Error");
        return;
    }
    // Select current node from Preorder traversal using preIndex
    newNode->data = preOrder[preIndex];
    preIndex++;
    if(inStrt == inEnd) /* if this node has no children then return */
        return newNode;
    /* else find the index of this node in Inorder traversal */
    int inIndex = Search(inOrder, inStrt, inEnd, newNode->data);
    /* Using index in Inorder traversal, construct left and right subtress */
    newNode->left = BuildBinaryTree(inOrder, preOrder, inStrt, inIndex-1);
    newNode->right = BuildBinaryTree(inOrder, preOrder, inIndex+1, inEnd);
    return newNode;
}
  
```

Time Complexity:  $O(n)$ . Space Complexity:  $O(n)$ .

**Problem-28** If we are given two traversal sequences, can we construct the binary tree uniquely?

**Solution:** It depends on what traversals are given. If one of the traversal methods is *Inorder* then the tree can be constructed uniquely, otherwise not.

Therefore, following combination can uniquely identify a tree:

- Inorder and Preorder
- Inorder and Postorder
- Inorder and Level-order

The following combinations do not uniquely identify a tree.

- Postorder and Preorder
- Preorder and Level-order
- Postorder and Level-order

For example, Preorder, Level-order and Postorder traversals are same for above trees:

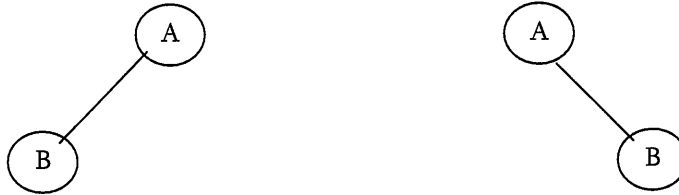

Preorder Traversal = AB      Postorder Traversal = BA      Level-order Traversal = AB

So, even if three of them (PreOrder, Level-Order and PostOrder) are given, tree cannot be constructed uniquely.

**Problem-29** Give an algorithm for printing all the ancestors of a node in a Binary tree. For the below tree, for 7 the ancestors are 1 3 7.

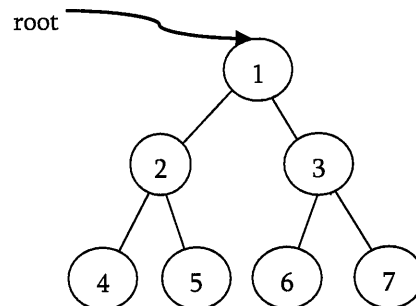

**Solution:** Apart from the Depth First Search of this tree, we can use the following recursive way to print the ancestors.

```
int PrintAllAncestors(struct BinaryTreeNode *root, struct BinaryTreeNode *node){
    if(root == NULL) return 0;
    if(root->left == node || root->right == node || PrintAllAncestors(root->left, node) ||
        PrintAllAncestors(root->right, node)) {
        printf("%d",root->data);
        return 1;
    }
    return 0;
}
```

Time Complexity:  $O(n)$ . Space Complexity:  $O(n)$  for recursion.

**Problem-30 Zigzag Tree Traversal:** Give an algorithm to traverse a binary tree in Zigzag order. For example, the output for the below tree should be: 1 3 2 4 5 6 7

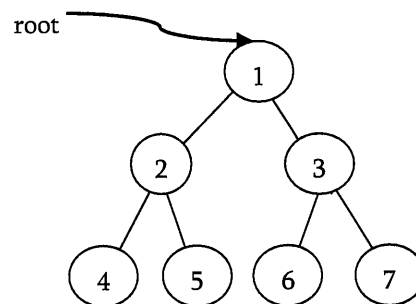

**Solution:** This problem can be solved easily using two stacks. Assume the two stacks are: *currentLevel* and *nextLevel*. We would also need a variable to keep track of the current level order (whether it is left to right or right to left).

We pop from *currentLevel* stack and print the nodes value. Whenever the current level order is from left to right, push the nodes left child, then its right child to stack *nextLevel*. Since a stack is a Last In First OUT (*LIFO*) structure, next time when nodes are popped off *nextLevel*, it will be in the reverse order. On the other hand, when the current level order is from right to left, we would push the nodes right child first, then its left child. Finally, don't forget to swap those two stacks at the end of each level (*i. e.*, when *currentLevel* is empty).

```
void ZigZagTraversal(struct BinaryTreeNode *root){
    struct BinaryTreeNode *temp;
    int leftToRight = 1;
    if(!root) return;
    struct Stack *currentLevel = CreateStack(), *nextLevel = CreateStack();
    Push(currentLevel, root);
    while(!IsEmptyStack(currentLevel)) {
        temp = Pop(currentLevel);
        if(temp) {
            printf("%d",temp->data);
            if(leftToRight) {
                if(temp->left) Push(nextLevel, temp->left);
                if(temp->right) Push(nextLevel, temp->right);
            }
            else {
                if(temp->right) Push(nextLevel, temp->right);
                if(temp->left) Push(nextLevel, temp->left);
            }
        }
        if(IsEmptyStack(currentLevel)) {
            leftToRight = 1-leftToRight;
            swap(currentLevel, nextLevel);
        }
    }
}
```

Time Complexity:  $O(n)$ . Space Complexity: Space for two stacks =  $O(n) + O(n) = O(n)$ .

**Problem-31** Give an algorithm for finding the vertical sum of a binary tree. For example,

The tree has 5 vertical lines

Vertical-1: nodes-4 => vertical sum is 4

Vertical-2: nodes-2 => vertical sum is 2

Vertical-3: nodes-1,5,6 => vertical sum is  $1 + 5 + 6 = 12$

Vertical-4: nodes-3 => vertical sum is 3

Vertical-5: nodes-7 => vertical sum is 7

We need to output: 4 2 12 3 7

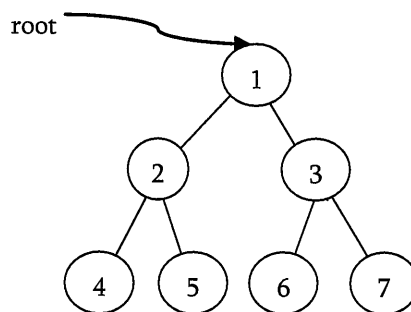

**Solution:** We can do an inorder traversal and hash the column. We call `VerticalSumInBinaryTree(root, 0)` which means the root is at column 0. While doing the traversal, hash the column and increase its value by `root → data`.

```

void VerticalSumInBinaryTree (struct BinaryTreeNode *root, int column){
    if(root==NULL) return;
    VerticalSumInBinaryTree(root->left, column-1);
    //Refer Hashing chapter for implementation of hash table
    Hash[column] += root->data;
    VerticalSumInBinaryTree(root->right, column+1);
}
VerticalSumInBinaryTree(root, 0);
Print Hash;

```

**Problem-32** How many different binary trees are possible with  $n$  nodes?

**Solution:** For example, consider a tree with 3 nodes ( $n = 3$ ), it will have the maximum combination of 5 different (i.e.,  $2^3 - 3 = 5$ ) trees.

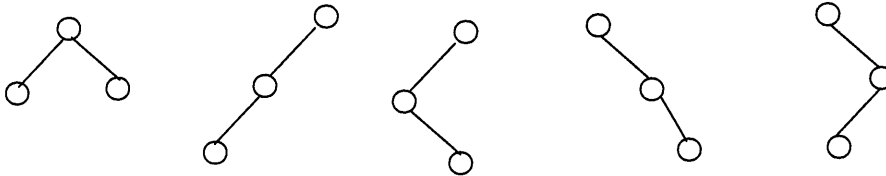

In general, if there are  $n$  nodes, there exist  $2^n - n$  different trees.

**Problem-33** Given a tree with a special property where leaves are represented with 'L' and internal node with 'I'. Also, assume that each node has either 0 or 2 children. Given preorder traversal of this tree, construct the tree [1].

**Example:** Given preorder string => ILILL

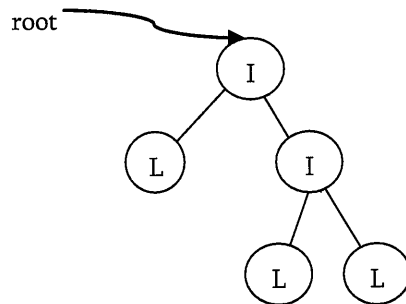

**Solution:** First, we should see how preorder traversal is arranged. Pre-order traversal means first put root node, then pre-order traversal of left subtree and then pre-order traversal of right subtree. In normal scenario, it's not possible to detect where left subtree ends and right subtree starts using only pre-order traversal. Since every node has either 2 children or no child, we can surely say that if a node exists then its sibling also exists. So every time we are computing a subtree, we need to compute its sibling subtree as well.

Secondly, whenever we get 'L' in the input string, that is a leaf and we can stop for a particular subtree at that point. After this 'L' node (left child of its parent 'L'), its sibling starts. If 'L' node is right child of its parent, then we need to go up in the hierarchy to find next subtree to compute. Keeping above invariant in mind, we can easily determine when a subtree ends and next start. It means that we can give any start node to our method and it can easily complete the subtree it generates going outside of its nodes. We just need to take care of passing correct start nodes to different sub-trees.

```

struct BinaryTreeNode *BuildTreeFromPreOrder(char* A, int *i){
    struct BinaryTreeNode *newNode;
    newNode = (struct BinaryTreeNode *) malloc(sizeof(struct BinaryTreeNode));
    newNode->data = A[*i];
    newNode->left = newNode->right = NULL;
    if(A == NULL){ //Boundary Condition
        free(newNode);
    }
}

```



```

        return NULL;
    }
    if(A[*i] == 'L') //On reaching leaf node, return
        return newNode;
    *i = *i + 1; //Populate left sub tree
    newNode->left = BuildTreeFromPreOrder(A, i);
    *i = *i + 1; //Populate right sub tree
    newNode->right = BuildTreeFromPreOrder(A, i);
    return newNode;
}

```

Time Complexity:  $O(n)$ .

**Problem-34** Given a binary tree with three pointers (left, right and nextSibling), give an algorithm for filling the *nextSibling* pointers assuming they are NULL initially.

**Solution:** We can use simple queue (similar to the solution of Problem-11). Let us assume that the structure of binary tree is:

```

struct BinaryTreeNode {
    struct BinaryTreeNode* left;
    struct BinaryTreeNode* right;
    struct BinaryTreeNode* nextSibling;
};

int FillNextSiblings(struct BinaryTreeNode *root){
    struct BinaryTreeNode *temp;
    struct Queue *Q;
    if(!root) return 0;
    Q = CreateQueue();
    EnQueue(Q,root);
    EnQueue(Q,NULL);
    while(!IsEmptyQueue(Q) {
        temp =DeQueue(Q);
        // Completion of current level.
        if(temp ==NULL) { //Put another marker for next level.
            if(!IsEmptyQueue(Q))
                EnQueue(Q,NULL);
        }
        else { temp->nextSibling = QueueFront(Q);
            if(root->left) EnQueue(Q, temp->left);
            if(root->right) EnQueue(Q, temp->right);
        }
    }
}

```

Time Complexity:  $O(n)$ . Space Complexity:  $O(n)$ .

**Problem-35** For Problem-34, is there any otherway of solving?

**Solution:** The trick is to re-use the populated *nextSibling* pointers. As mentioned earlier, we just need one more step for it to work. Before we passed the *left* and *right* to the recursion function itself, we connect the right childs *nextSibling* to the current nodes nextSibling left child. In order for this to work, the current node *nextSibling* pointer must be populated, which is true in this case.

```

void FillNextSiblings(struct BinaryTreeNode* root) {
    if (!root) return;
}

```

```

if (root→left) root→left→nextSibling = root→right;
if (root→right)
    root→right→nextSibling = (root→nextSibling) ? root→nextSibling→left : NULL;
FillNextSiblings(root→left);
FillNextSiblings(root→right);
}

```

Time Complexity:  $O(n)$ .

## 6.7 Generic Trees (N-ary Trees)

In the previous section we have discussed binary trees where each node can have maximum of two children only and represented them easily with two pointers. But suppose if we have a tree with many children at every node and also if we do not know how many children a node can have, how do we represent them? For example, consider the tree shown above.

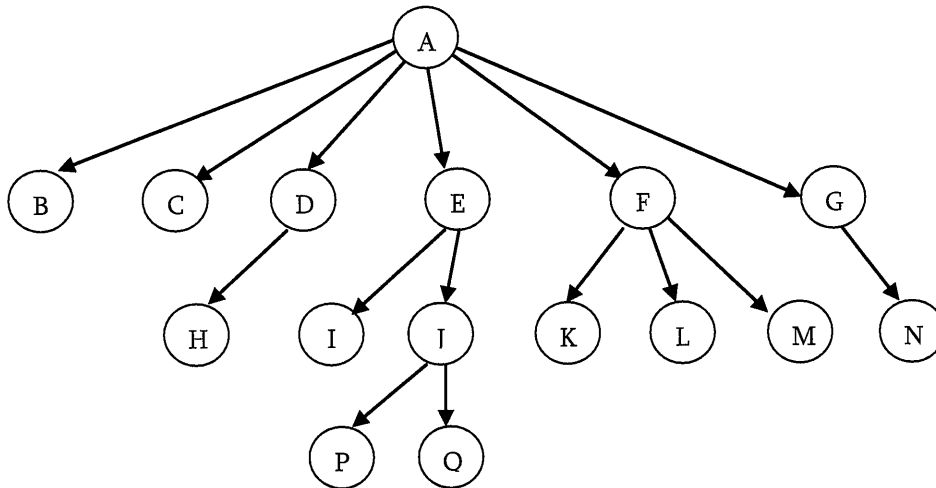

### For a tree like this, how do we represent the tree?

In the above tree, there are nodes with 6 children, with 3 children, 2 children, with 1 child, and with zero children (leaves). To present this tree we have to consider the worst case (6 children) and allocate those many child pointers for each node. Based on this, the node representation can be given as:

```

struct TreeNode{
    int data;
    struct TreeNode *firstChild;
    struct TreeNode *secondChild;
    struct TreeNode *thirdChild;
    struct TreeNode *fourthChild;
    struct TreeNode *fifthChild;
    struct TreeNode *sixthChild;
};

```

Since we are not using all the pointers in all the cases there is a lot of memory wastage. Also, another problem is that, in advance we do not know the number of children for each node. In order to solve this problem we need a representation that minimizes the wastage and also accept nodes with any number of children.

### Representation of Generic Trees

Since our objective is to reach all nodes of the tree, a possible solution to this is as follows:

- At each node link children of same parent (siblings) from left to right.
- Remove the links from parent to all children except the first child.

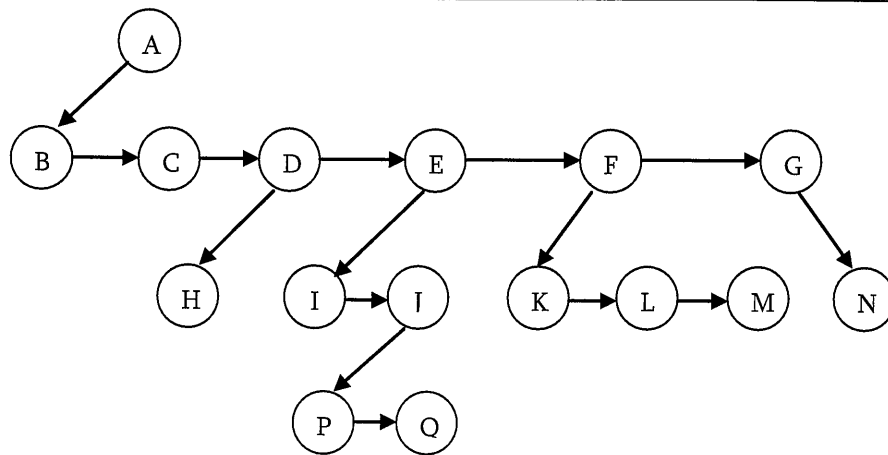

What these above statements say is if we have a link between children then we do not need extra links from parent to all children. This is because we can traverse all the elements by starting at the first child of the parent. So if we have link between parent and first child and also links between all children of same parent then it solves our problem. This representation is sometimes called first child/next sibling representation. First child/next sibling representation of the generic tree is shown above. The actual representation for this tree is:

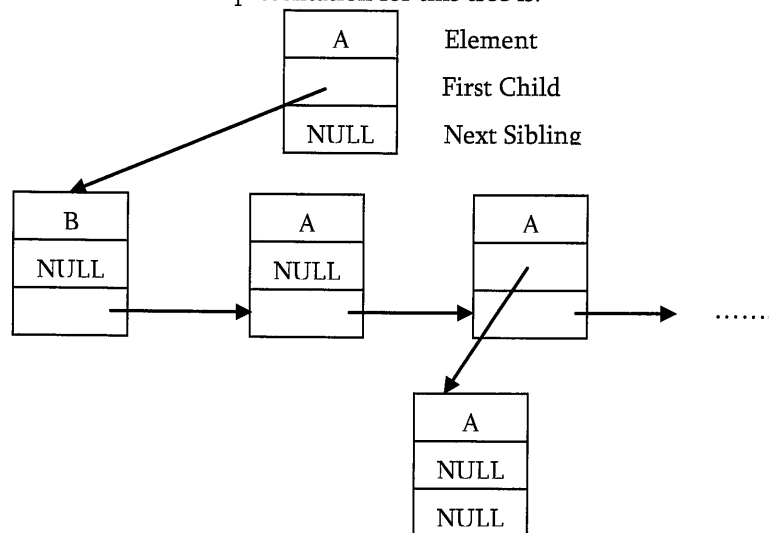

Based on this discussion, the tree node declaration for general tree can be given as:

```
struct TreeNode {
    int data;
    struct TreeNode *firstChild;
    struct TreeNode *nextSibling;
};
```

**Note:** Since we are able to represent any generic tree with binary representation, in practice we use only binary tree.

## Problems on Generic Trees

**Problem-36** Given a tree, give an algorithm for finding the sum of all the elements of the tree.

**Solution:** The solution is similar to what we have done for simple binary trees. That means, traverse the complete list and keep on adding the values. We can either use level order traversal or simple recursion.

```
int FindSum(struct TreeNode *root){
    if(!root) return 0;
    return root->data + FindSum(root->firstChild) + FindSum(root->sibling);
}
```

Time Complexity:  $O(n)$ . Space Complexity:  $O(1)$  (if we do not consider stack space), otherwise  $O(n)$ .

**Note:** All problems which we have discussed for binary trees are applicable for generic trees also. Instead of left and right pointers we just need to use firstChild and nextSibling.

**Problem-37** For a 4-ary tree (each node can contain maximum of 4 children), what is the maximum possible height with 100 nodes? Assume height of a single node is 0.

**Solution:** In 4-ary tree each node can contain 0 to 4 children and to get maximum height, we need to keep only one child for each parent. With 100 nodes the maximum possible height we can get is 99. If we have a restriction that at least one node is having 4 children, then we keep one node with 4 children and remaining all nodes with 1 child. In this case, the maximum possible height is 96. Similarly, with  $n$  nodes the maximum possible height is  $n - 4$ .

**Problem-38** For a 4-ary tree (each node can contain maximum of 4 children), what is the minimum possible height with  $n$  nodes?

**Solution:** Similar to above discussion, if we want to get minimum height, then we need to fill all nodes with maximum children (in this case 4). Now let's see the following table, which indicates the maximum number of nodes for a given height.

Height, h	Maximum Nodes at height, $h = 4^h$	Total Nodes height $h = \frac{4^{h+1}-1}{3}$
0	1	1
1	4	1+4
2	4 × 4	1+ 4 × 4
3	4 × 4 × 4	1+ 4 × 4 + 4 × 4 × 4

For a given height  $h$  the maximum possible nodes are:  $\frac{4^{h+1}-1}{3}$ . To get minimum height, take logarithm on both sides:

$$n = \frac{4^{h+1}-1}{3} \Rightarrow 4^{h+1} = 3n + 1 \Rightarrow (h + 1)\log 4 = \log(3n + 1) \Rightarrow h + 1 = \log_4(3n + 1) \Rightarrow h = \log_4(3n + 1) - 1$$

**Problem-39** Given a parent array  $P$ , where  $P[i]$  indicates the parent of  $i^{\text{th}}$  node in the tree (assume parent of root node is indicated with  $-1$ ). Give an algorithm for finding the height or depth of the tree.

**Solution:**

For example: if the P is

-1	0	1	6	6	0	0	2	7
0	1	2	3	4	5	6	7	8

Its corresponding tree is:

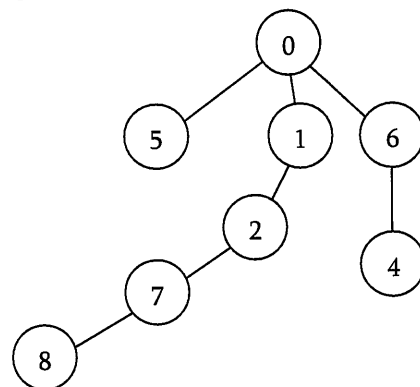

From the problem definition, the given array is representing the parent array. That means, we need to consider the tree for that array and find the depth of the tree. The depth of this given tree is 4. If we carefully observe, we just need to start at every node and keep going to its parent until we reach  $-1$  and also keep track of the maximum depth among all nodes.

```

int FindDepthInGenericTree(int P[], int n){
    int maxDepth = -1, currentDepth = -1, j;
    for (int i = 0; i < n; i++) {
  
```

```

        currentDepth = 0; j = i;
        while(P[j] != -1) {
            currentDepth++; j = P[j];
        }
        if(currentDepth > maxDepth)
            maxDepth = currentDepth;
    }
    return maxDepth;
}

```

Time Complexity:  $O(n^2)$ . For skew trees we will be re-calculating the same values. Space Complexity:  $O(1)$ .

**Note:** We can optimize the code by storing the previous calculated nodes depth in some hash table or other array. This reduces the time complexity but uses extra space.

**Problem-40** Given a node in the generic tree, give an algorithm for counting the number of siblings for that node.

**Solution:** Since tree is represented with first child/next sibling method, the tree structure can be given as:

```

struct TreeNode{
    int data;
    struct TreeNode *firstChild;
    struct TreeNode *nextSibling;
};

```

For a given node in the tree, we just need to traverse all its nextsiblings.

```

int SiblingsCount(struct TreeNode *current){
    int count = 0;
    while(current) {
        count++;
        current = current->nextSibling;
    }
    return count;
}

```

Time Complexity:  $O(n)$ . Space Complexity:  $O(1)$ .

**Problem-41** Given a node in the generic tree, give an algorithm for counting the number of children for that node.

**Solution:** Since the tree is represented as first child/next sibling method, the tree structure can be given as:

```

struct TreeNode{
    int data;
    struct TreeNode *firstChild;
    struct TreeNode *nextSibling;
};

```

For a given node in the tree, we just need to point to its first child and keep traversing all its nextsiblings.

```

int ChildCount(struct TreeNode *current){
    int count = 0;
    current = current->firstChild;
    while(current) {
        count++;
        current = current->nextSibling;
    }
    return count;
}

```

Time Complexity:  $O(n)$ . Space Complexity:  $O(1)$ .

**Problem-42** Given two trees how do we check whether the trees are isomorphic to each other or not?

**Solution:** Two binary trees *root1* and *root2* are isomorphic if they have the same structure. The values of the nodes does not affect whether two trees are isomorphic or not. In the diagram below, the tree in the middle is not isomorphic to the other trees, but the tree on the right is isomorphic to the tree on the left.

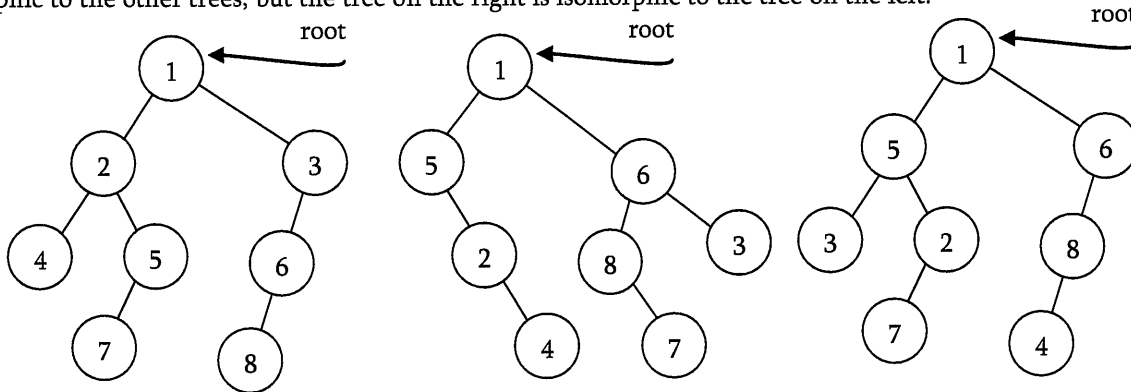

```
int IsIsomorphic(struct TreeNode *root1, struct TreeNode *root2){
    if(!root1 && !root2) return 1;
    if((!root1 && root2) || (root1 && !root2))
        return 0;
    return (IsIsomorphic(root1->left, root2->left) && IsIsomorphic(root1->right, root2->right));
}
```

Time Complexity:  $O(n)$ . Space Complexity:  $O(n)$ .

**Problem-43** Given two trees how do we check whether they are quasi-isomorphic to each other or not?

**Solution:**

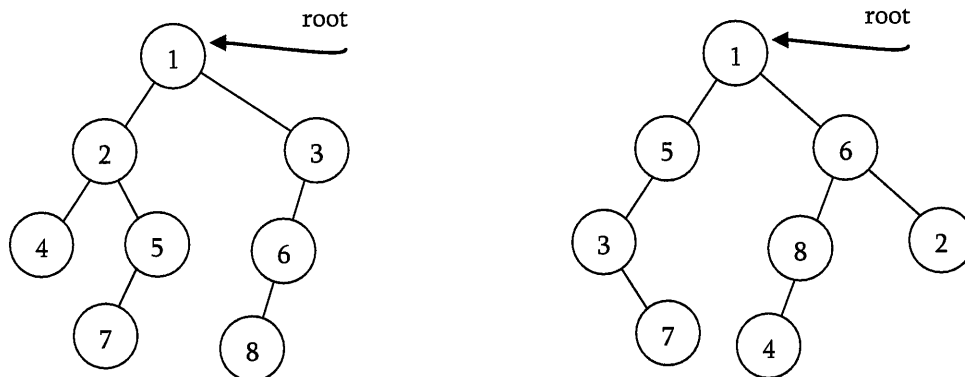

Two trees *root1* and *root2* are quasi-isomorphic if *root1* can be transformed into *root2* by swapping left and right children of some of the nodes of *root1*. The data in the nodes are not important in determining quasi-isomorphism, only the shape is important. The trees below are quasi-isomorphic because if the children of the nodes on the left are swapped, the tree on the right is obtained.

```
int QuasiIsomorphic(struct TreeNode *root1, struct TreeNode *root2){
    if(!root1 && !root2) return 1;
    if((!root1 && root2) || (root1 && !root2))
        return 0;
    return (QuasiIsomorphic(root1->left, root2->left) && QuasiIsomorphic(root1->right, root2->right)
        || QuasiIsomorphic(root1->right, root2->left) && QuasiIsomorphic(root1->left, root2->right));
}
```

Time Complexity:  $O(n)$ . Space Complexity:  $O(n)$ .

**Problem-44** A full  $k$ -ary tree is a tree where each node has either 0 or  $k$  children. Given an array which contains the preorder traversal of full  $k$ -ary tree, give an algorithm for constructing the full  $k$ -ary tree.

**Solution:** In  $k$ -ary tree, for a node at  $i^{\text{th}}$  position its children will be at  $k * i + 1$  to  $k * i + k$ . For example, the below is an example for full 3-ary tree.

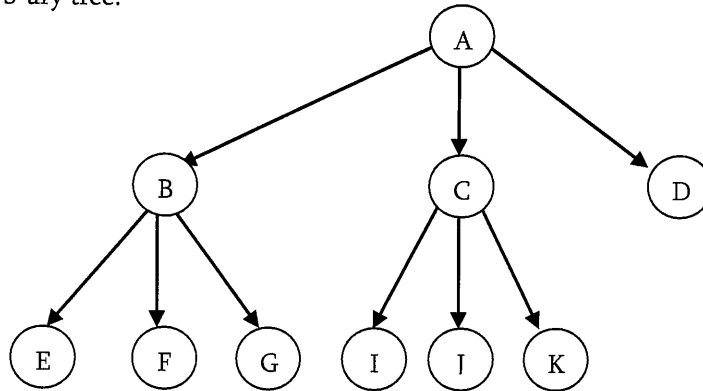

As we have seen, in preorder traversal first left subtree is processed then followed by root node and right subtree. Because of this, to construct a full  $k$ -ary, we just need to keep on creating the nodes without bothering about the previous constructed nodes. We can use this trick to build the tree recursively by using one global index. Declaration for  $k$ -ary tree can be given as:

```

struct K-aryTreeNode{
    char data;
    struct K-aryTreeNode *child[];
};
int *Ind = 0;
struct K-aryTreeNode *BuildK-aryTree(char A[], int n, int k){
    if(n<=0)
        return NULL;
    struct K-aryTreeNode *newNode = (struct K-aryTreeNode*) malloc(sizeof(struct K-aryTreeNode));
    if(!newNode) {
        printf("Memory Error");
        return;
    }
    newNode->child = (struct K-aryTreeNode*) malloc( k * sizeof(struct K-aryTreeNode));
    if(!newNode->child) {
        printf("Memory Error");
        return;
    }
    newNode->data = A[Ind];
    for (int i = 0; i<k; i++) {
        if(k * Ind + i <n) {
            Ind++;
            newNode->child[i] = BuildK-aryTree(A, n, k,Ind );
        }
        else newNode->child[i] =NULL;
    }
    return newNode;
}

```

Time Complexity:  $O(n)$ , where  $n$  is the size of the pre-order array. This is because we are moving sequentially and not visiting the already constructed nodes.

## 6.8 Threaded Binary Tree Traversals [Stack or Queue less Traversals]

In earlier sections we have seen that, *preorder*, *inorder* and *postorder* binary tree traversals used stacks and *level order* traversal used queues as an auxiliary data structure. In this section we will discuss new traversal algorithms which do not need both stacks and queues and such traversal algorithms are called *threaded binary tree traversals* or *stack/queue less traversals*.

### Issues with Regular Binary Tree Traversals

- The storage space required for the stack and queue is large.
- The majority of pointers in any binary tree are NULL. For example, a binary tree with  $n + 1$  NULL pointers and these were wasted.

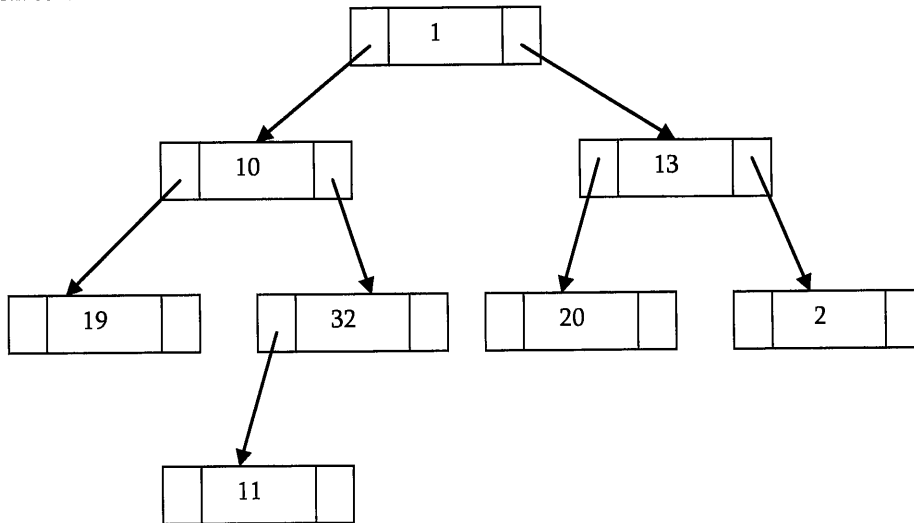

- It is difficult to find successor node (preorder, inorder and postorder successors) for a given node.

### Motivation for Threaded Binary Trees

To solve these problems, one idea is to store some useful information in NULL pointers. If we observe previous traversals carefully, *stack/queue* is required because we have to record the current position in order to move to right subtree after processing the left subtree. If we store the useful information in NULL pointers, then we don't have to store such information in *stack/queue*. The binary trees which store such information in NULL pointers are called *threaded binary trees*. From the above discussion, let us assume that we have decided to store some useful information in NULL pointers. The next question is what to store?

The common convention is put predecessor/successor information. That means, if we are dealing with *preorder* traversals then for a given node, NULL left pointer will contain *preorder* predecessor information and NULL right pointer will contain *preorder* successor information. These special pointers are called *threads*.

### Classifying Threaded Binary Trees

The classification is based on whether we are storing useful information in both NULL pointers or only in one of them.

- If we store predecessor information in NULL left pointers only then we call such binary trees as *left threaded binary trees*.
- If we store successor information in NULL right pointers only then we call such binary trees as *right threaded binary trees*.
- If we store predecessor information in NULL left pointers only then we call such binary trees as *fully threaded binary trees* or simply *threaded binary trees*.



**Note:** For the remaining discussion we consider only (*fully*) *threaded binary trees*.

## Types of Threaded Binary Trees

Cased on above discussion we get three representations for threaded binary trees.

- *Preorder Threaded Binary Trees*: NULL left pointer will contain PreOrder predecessor information and NULL right pointer will contain PreOrder successor information
- *Inorder Threaded Binary Trees*: NULL left pointer will contain InOrder predecessor information and NULL right pointer will contain InOrder successor information
- *Postorder Threaded Binary Trees*: NULL left pointer will contain PostOrder predecessor information and NULL right pointer will contain PostOrder successor information

**Note:** As the representations are similar, for the remaining discussion, we will use InOrder threaded binary trees.

## Threaded Binary Tree structure

Any program examining the tree must be able to differentiate between a regular *left/right* pointer and a *thread*. To do this, we use two additional fields into each node giving us, for threaded trees, nodes of the following form:

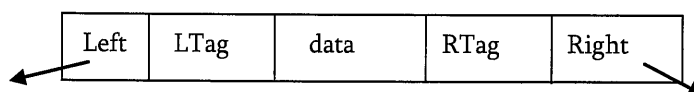

```
struct ThreadedBinaryTreeNode{
    struct ThreadedBinaryTreeNode *left;
    int LTag;
    int data;
    int RTag;
    struct ThreadedBinaryTreeNode *right;
};
```

## Difference between Binary Tree and Threaded Binary Tree Structures

	Regular Binary Trees	Threaded Binary Trees
if LTag == 0	NULL	left points to the in-order predecessor
if LTag == 1	left points to the left child	left points to left child
if RTag == 0	NULL	right points to the in-order successor
if RTag == 1	right points to the right child	right points to the right child

**Note:** Similarly, we can define for preorder/postorder differences as well.

As an example, let us try representing a tree in inorder threaded binary tree form. The below tree shows how an inorder threaded binary tree will look like. The dotted arrows indicate the threads. If we observe, the left pointer of left most node (2) and right pointer of right most node (31) are hanging.

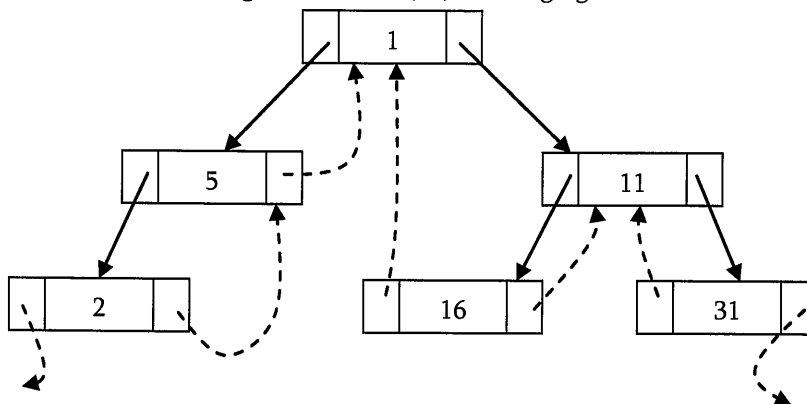

What should leftmost and rightmost pointers point to?

In the representation of a threaded binary tree, it is convenient to use a special node *Dummy* which is always present even for an empty tree. Note that, right tag of dummy node is 1 and its right child points to itself.

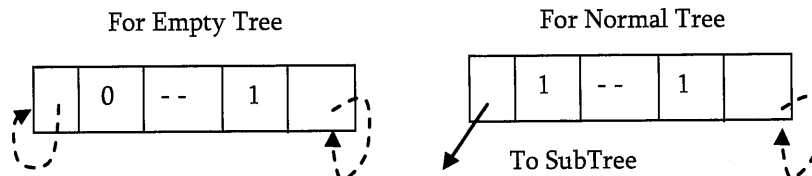

With this convention the above tree can be represented as:

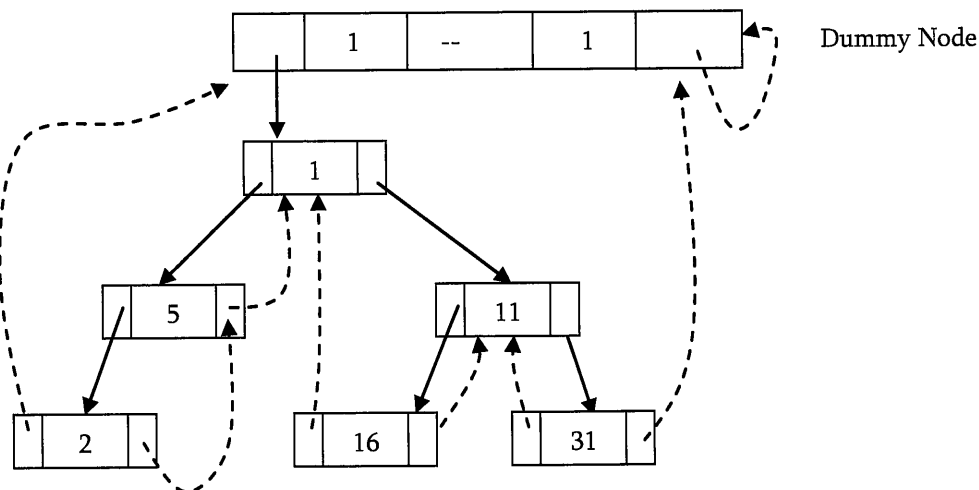

## Finding Inorder Successor in Inorder Threaded Binary Tree

To find inorder successor of a given node without using a stack, assume that the node for which we want to find the inorder successor is  $P$ .

**Strategy:** If  $P$  has a no right subtree, then return the right child of  $P$ . If  $P$  has right subtree, then return the left of the nearest node whose left subtree contains  $P$ .

```
struct ThreadedBinaryTreeNode* InorderSuccessor(struct ThreadedBinaryTreeNode *P){
    struct ThreadedBinaryTreeNode *Position;
    if(P->RTag == 0) return P->right;
    else {
        Position = P->right;
        while(Position->LTag == 1)
            Position = Position->left;
        return Position;
    }
}
```

Time Complexity:  $O(n)$ . Space Complexity:  $O(1)$ .

## Inorder Traversal in Inorder Threaded Binary Tree

We can start with *dummy* node and call `InorderSuccessor()` to visit each node until we reach *dummy* node.

```
void InorderTraversal(struct ThreadedBinaryTreeNode *root){
    struct ThreadedBinaryTreeNode *P = InorderSuccessor(root);
    while(P != root) {
        P = InorderSuccessor(P);
        printf("%d", P->data);
    }
}
```

```

    }
}

```

**Other way of coding:**

```

void InorderTraversal(struct ThreadedBinaryTreeNode *root){
    struct ThreadedBinaryTreeNode *P = root;
    while(1) { P = InorderSuccessor(P);
        if(P == root) return;
        printf("%d",P->data);
    }
}

```

Time Complexity:  $O(n)$ . Space Complexity:  $O(1)$ .

### Finding PreOrder Successor in InOrder Threaded Binary Tree

**Strategy:** If  $P$  has a left subtree, then return the left child of  $P$ . If  $P$  has no left subtree, then return the right child of the nearest node whose right subtree contains  $P$ .

```

struct ThreadedBinaryTreeNode* PreorderSuccessor(struct ThreadedBinaryTreeNode *P){
    struct ThreadedBinaryTreeNode *Position;
    if(P->LTag == 1) return P->left;
    else { Position = P;
        while(Position->RTag == 0)
            Position = Position->right;
        return Position->right;
    }
}

```

Time Complexity:  $O(n)$ . Space Complexity:  $O(1)$ .

### PreOrder Traversal of InOrder Threaded Binary Tree

As similar to inorder traversal, start with *dummy* node and call PreorderSuccessor() to visit each node until we get *dummy* node again.

```

void PreorderTraversal(struct ThreadedBinaryTreeNode *root){
    struct ThreadedBinaryTreeNode *P;
    P = PreorderSuccessor(root);
    while(P != root) {
        P = PreorderSuccessor(P);
        printf("%d",P->data);
    }
}

```

**Other way of coding:**

```

void PreorderTraversal(struct ThreadedBinaryTreeNode *root) {
    struct ThreadedBinaryTreeNode *P = root;
    while(1){P = PreorderSuccessor(P);
        if(P == root) return;
        printf("%d",P->data);
    }
}

```

Time Complexity:  $O(n)$ . Space Complexity:  $O(1)$ .

**Note:** From the above discussion, it should be clear that inorder and preorder successor finding is easy with threaded binary trees. But finding postorder successor is very difficult if we do not use stack.

## Insertion of Nodes in InOrder Threaded Binary Trees

For simplicity, let us assume that there are two nodes  $P$  and  $Q$  and we want to attach  $Q$  to right of  $P$ . For this we will have two cases.

- Node  $P$  does not has right child: In this case we just need to attach  $Q$  to  $P$  and change its left and right pointers.

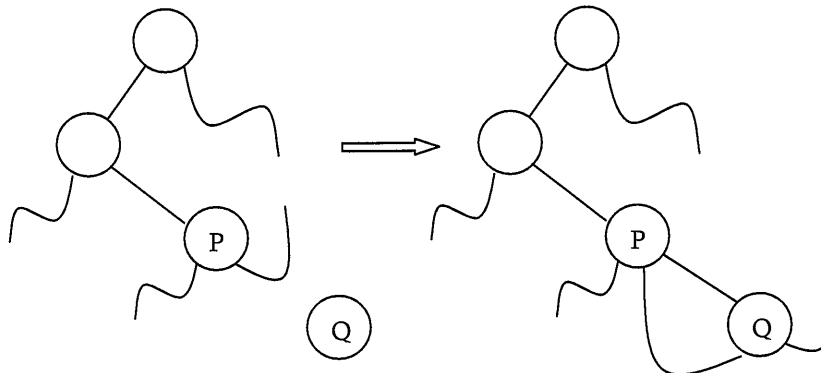

- Node  $P$  has right child (say,  $R$ ): In this case we need to traverse  $R$ 's left subtree and find the left most node and then update the left and right pointer of that node (as shown below).

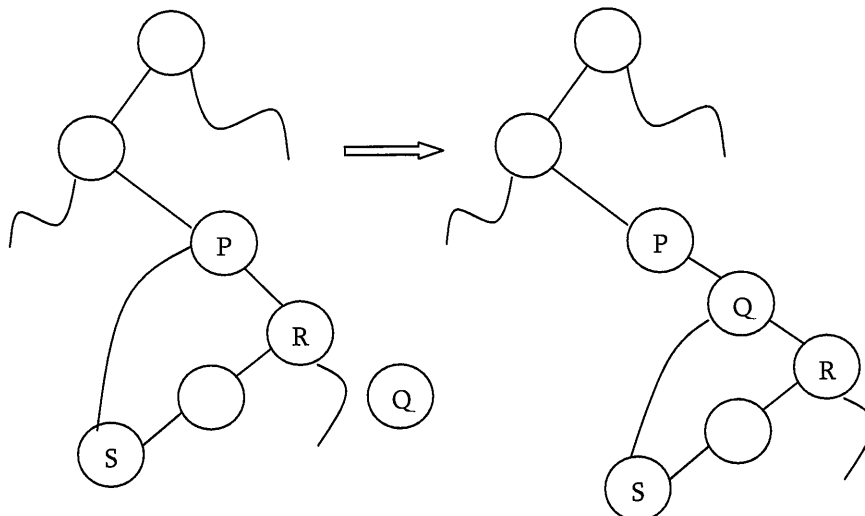

```
void InsertRightInInorderTBT(struct ThreadedBinaryTreeNode *P, struct ThreadedBinaryTreeNode *Q){
    struct ThreadedBinaryTreeNode *Temp;
    Q->right = P->right;
    Q->RTag = P->RTag;
    Q->left = P;
    Q->LTag = 0;
    P->right = Q;
    P->RTag = 1;
    if(Q->RTag == 1) { //Case-2
        Temp = Q->right;
        while(Temp->LTag)
            Temp = Temp->left;
        Temp->left = Q;
    }
}
```

Time Complexity:  $O(n)$ . Space Complexity:  $O(1)$ .

## Problems on Threaded binary Trees

**Problem-45** For a given binary tree (not threaded) how do we find the preorder successor?

**Solution:** For solving this problem, we need to use an auxiliary stack  $S$ . On the first call, the parameter node is a pointer to the head of the tree, thereafter its value is NULL. Since we are simply asking for the successor of the node we got last time we called the function. It is necessary that the contents of the stack  $S$  and the pointer  $P$  to the last node “visited” are preserved from one call of the function to the next, they are defined as static variables.

```
// pre-order successor for an unthreaded binary tree
struct BinaryTreeNode *PreorderSuccessor(struct BinaryTreeNode *node){
    static struct BinaryTreeNode *P;
    static Stack *S = CreateStack();
    if(node != NULL)
        P = node;
    if(P->left != NULL) {
        Push(S,P);
        P = P->left;
    }
    else { while (P->right = NULL)
            P = Pop(S);
          P = P->right;
    }
    return P;
}
```

**Problem-46** For a given binary tree (not threaded) how do we find the inorder successor?

**Solution:** Similar to above discussion, we can find the inorder successor of a node as:

```
// In-order successor for an unthreaded binary tree
struct BinaryTreeNode *InorderSuccessor(struct BinaryTreeNode *node){
    static struct BinaryTreeNode *P;
    static Stack *S = CreateStack();
    if(node != NULL)
        P = node;
    if(P->right == NULL)
        P = Pop(S);
    else { P = P->right;
          while (P->left != NULL)
              Push(S, P);
          P = P->left;
        }
    return P;
}
```

## 6.9 Expression Trees

A tree representing an expression is called as an expression tree. In expression trees leaf nodes are operands and non-leaf nodes are operators. That means, an expression tree is a binary tree where internal nodes are operators and leaves are operands. Expression tree consists of binary expression. But for a unary operator, one subtree will be empty. Below figure shows a simple expression tree for  $(A + B * C) / D$ .

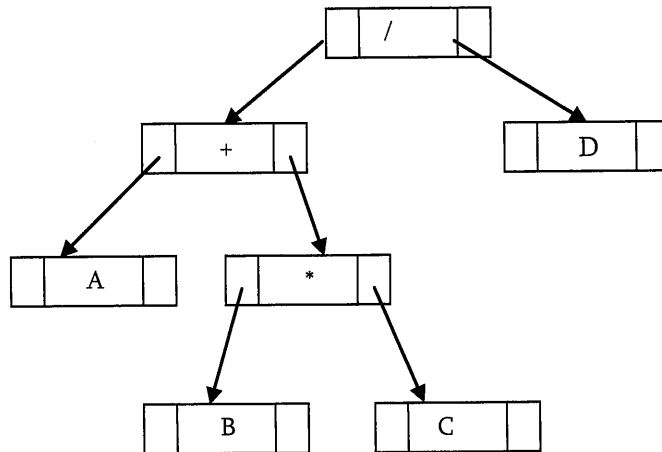

### Algorithm for Building Expression Tree from Postfix Expression

```

struct BinaryTreeNode *BuildExprTree(char postfixExpr[], int size){
    struct Stack *S = Stack(size);
    for (int i = 0; i < size; i++) {
        if(postfixExpr[i] is an operand) {
            struct BinaryTreeNode newNode = (struct BinaryTreeNode*)
                malloc( sizeof (struct BinaryTreeNode));
            if(!newNode) {
                printf("Memory Error");
                return;
            }
            newNode->data =postfixExpr[i];
            newNode->left = newNode->right = NULL;
            Push(S, newNode);
        }
        else {
            struct BinaryTreeNode *T2 = Pop(S), *T1 = Pop(S);
            struct BinaryTreeNode newNode = (struct BinaryTreeNode*)
                malloc(sizeof(struct BinaryTreeNode));
            if(!newNode) {
                printf("Memory Error"); return;
            }
            newNode->data = postfixExpr[i];
            newNode->left = T1; newNode->right = T2;
            Push(S, newNode);
        }
    }
    return S;
}

```

**Example:** Assume that one symbol is read at a time. If the symbol is an operand, we create a tree node and push a pointer to it onto a stack. If the symbol is an operator, pop pointers to two trees  $T_1$  and  $T_2$  from the stack ( $T_1$  is popped first) and form a new tree whose root is the operator and whose left and right children point to  $T_2$  and  $T_1$  respectively. A pointer to this new tree is then pushed onto the stack.

As an example, assume the input is A B C \* + D /. The first three symbols are operands, so create tree nodes and push pointers to them onto a stack as shown below.

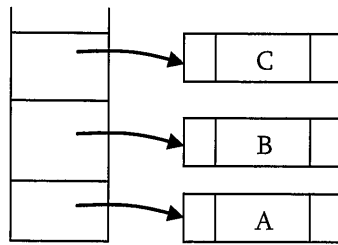

Next, an operator '\*' is read, so two pointers to trees are popped, a new tree is formed and a pointer to it is pushed onto the stack.

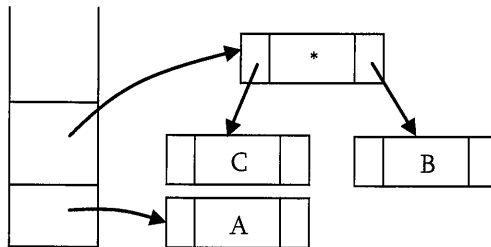

Next, an operator '+' is read, so two pointers to trees are popped, a new tree is formed and a pointer to it is pushed onto the stack.

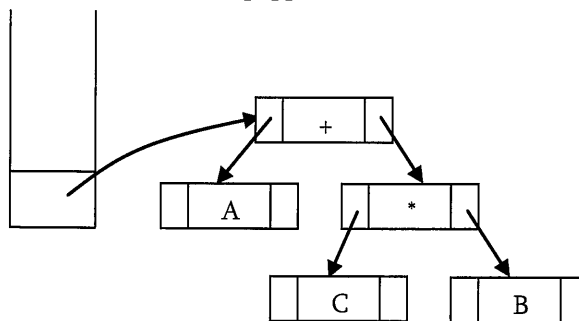

Next, an operand 'D' is read, a one-node tree is created and a pointer to the corresponding tree is pushed onto the stack.

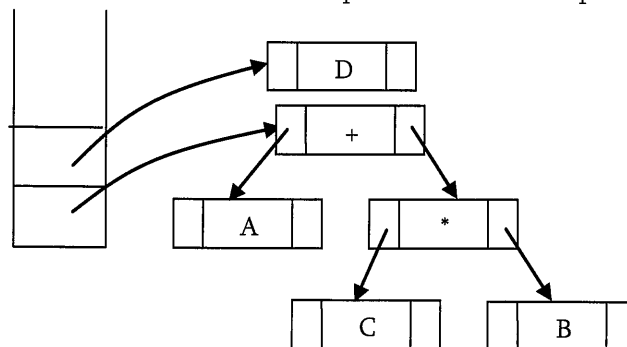

Finally, the last symbol ('/') is read, two trees are merged and a pointer to the final tree is left on the stack.

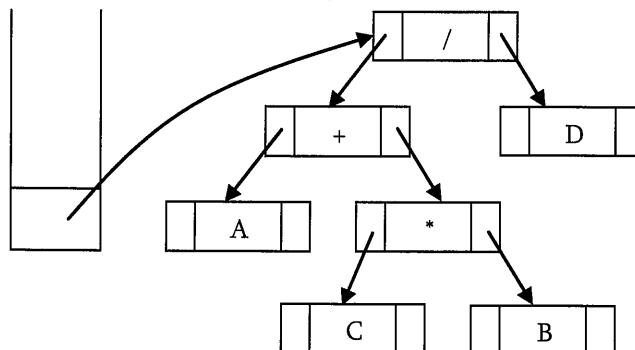

## 6.10 XOR Trees

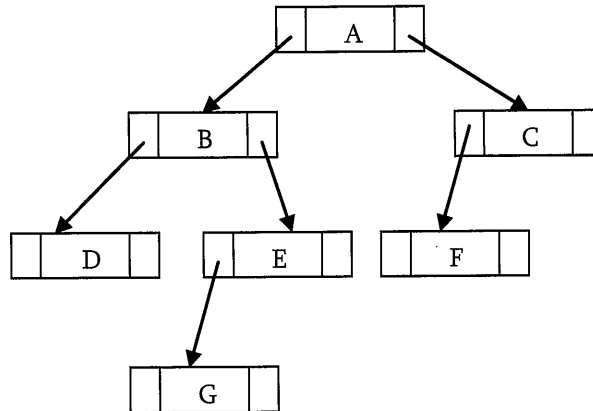

This concept is very much similar to *memory efficient doubly linked lists* of *Linked Lists* chapter. Also, like threaded binary trees this representation does not need stacks or queues for traversing the trees. This representation is used for traversing back (to parent) and forth (to children) using  $\oplus$  operation. To represent the same in XOR trees, for each node below are the rules used for representation:

- Each nodes left will have the  $\oplus$  of its parent and its left children.
- Each nodes right will have the  $\oplus$  of its parent and its right children.
- The root nodes parent is NULL and also leaf nodes children are NULL nodes.

Based on the above rules and discussion the tree can be represented as:

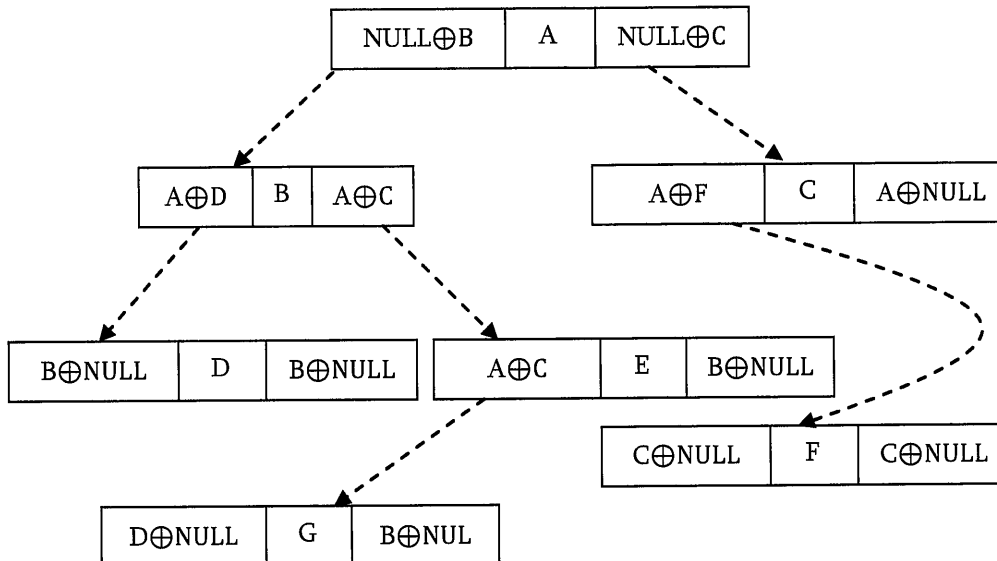

The major objective of this presentation is ability to move to parent as well to children. Now, let us see how to use this representation for traversing the tree. For example, if we are at node B and want to move to its parent node A, then we just need to perform  $\oplus$  on its left content with its left child address (we can use right child also for going to parent node).

Similarly, if we want to move to its child (say, left child D) then we have to perform  $\oplus$  on its left content with its parent node address. One important point that we need to understand about this representation is: When we are at parent node address. How do we know the address of its children D? Since the traversal starts at node root node, we can apply  $\oplus$  on root's left content with NULL. As a result we get its left child, B. When we are at B, we can apply  $\oplus$  on its left content with A address.



## 6.11 Binary Search Trees (BSTs)

### Why Binary Search Trees?

In previous sections we have discussed different tree representations and in all of them we did not impose any restriction on the nodes data. As a result, to search for an element we need to check both in left subtree and also right subtree. Due to this, the worst case complexity of search operation is  $O(n)$ .

In this section, we will discuss another variant of binary trees: Binary Search Trees (BSTs). As the name suggests, the main use of this representation is for *searching*. In this representation we impose restriction on the kind of data a node can contain. As a result, it reduces the worst case average search operation to  $O(\log n)$ .

### Binary Search Tree Property

In binary search trees, all the left subtree elements should be less than root data and all the right subtree elements should be greater than root data. This is called binary search tree property. Note that, this property should be satisfied at every node in the tree.

- The left subtree of a node contains only nodes with keys less than the nodes key.
- The right subtree of a node contains only nodes with keys greater than the nodes key.
- Both the left and right subtrees must also be binary search trees.

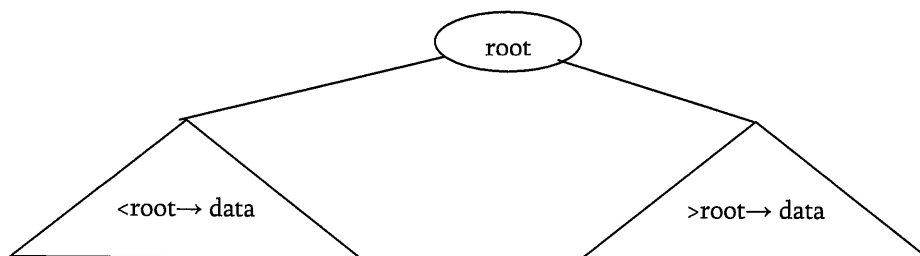

**Example:** The left tree is a binary search tree and right tree is not binary search tree (at node 6 it's not satisfying the binary search tree property).

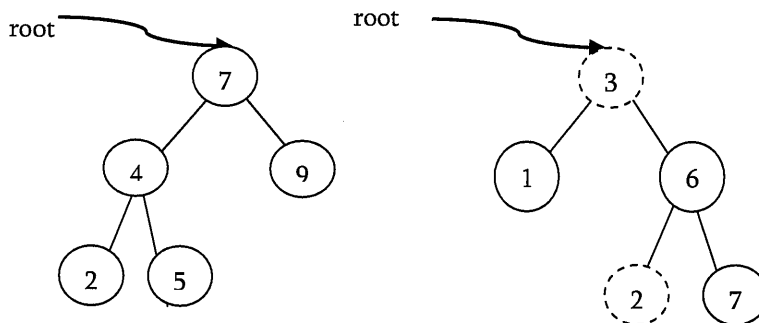

### Binary Search Tree Declaration

There is no difference between regular binary tree declaration and binary search tree declaration. The difference is only in data but not in structure. But for our convenience we change the structure name as:

```
struct BinarySearchTreeNode{
    int data;
    struct BinarySearchTreeNode *left;
    struct BinarySearchTreeNode *right;
};
```

## Operations on Binary Search Trees

**Main operations:** The main operations that were supported by binary search trees are:

- Find/ Find Minimum / Find Maximum element in binary search trees
- Inserting an element in binary search trees
- Deleting an element from binary search trees

**Auxiliary operations:** Checking whether the given tree is a binary search tree or not

- Finding  $k^{th}$ -smallest element in tree
- Sorting the elements of binary search tree and many more

## Important Notes on Binary Search Trees

- Since root data is always in between left subtree data and right subtree data, performing inorder traversal on binary search tree produces a sorted list.
- While solving problems on binary search trees, most of the time, first we process left subtree, process root data and then process right subtree. That means, depending on the problem only the intermediate step (processing root data) changes and we will not touch first and third steps.
- If we are searching for an element and if the left subtree roots data is less than the element we want to search then skip it. Same is the case with right subtree as well. Because of this binary search trees takes less time for searching an element than regular binary trees. In other words, the binary search trees consider only either left or right subtrees for searching an element but not both.

## Finding an Element in Binary Search Trees

Find operation is straightforward in a BST. Start with the root and keep moving left or right using the BST property. If the data we are searching is same as nodes data then we return current node. If the data we are searching is less than nodes data then search left subtree of current node otherwise search in right subtree of current node. If the data is not present, we end up in a NULL link.

```
struct BinarySearchTreeNode *Find(struct BinarySearchTreeNode *root, int data ){
    if( root == NULL )
        return NULL;
    if( data < root->data )
        return Find(root->left, data);
    else if( data > root->data )
        return( Find( root->right, data );
    return root;
}
```

Time Complexity:  $O(n)$ , in worst case (when BST is a skew tree). Space Complexity:  $O(n)$ , for recursive stack.

*Non recursive* version of the above algorithm can be given as:

```
struct BinarySearchTreeNode *Find(struct BinarySearchTreeNode *root, int data ){
    if( root == NULL ) return NULL;
    while (root) {
        if(data == root->data)
            return root;
        else if(data > root->data)
            root = root->right;
        else
            root = root->left;
    }
    return NULL;
}
```

Time Complexity:  $O(n)$ . Space Complexity:  $O(1)$ .

### Finding Minimum Element in Binary Search Trees

In BSTs, the minimum element is the left most node which does not has left child. In the below BST, the minimum element is 4.

```
struct BinarySearchTreeNode *FindMin(struct BinarySearchTreeNode *root){
    if(root == NULL) return NULL;
    else    if( root->left == NULL )
            return root;
            else return FindMin( root->left );
}
```

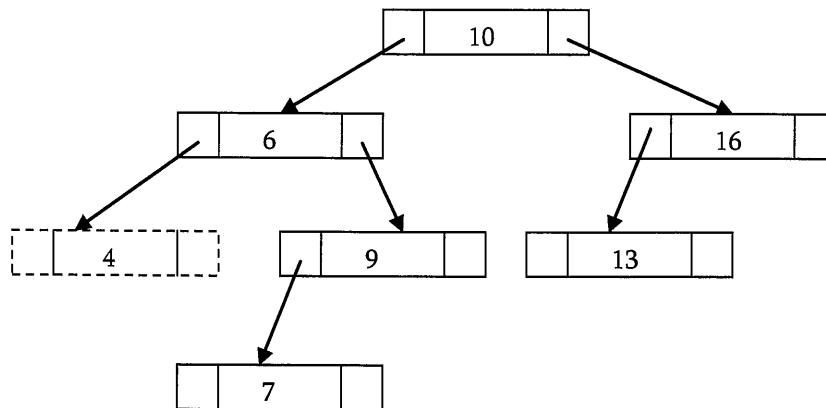

Time Complexity:  $O(n)$ , in worst case (when BST is a *left skew* tree). Space Complexity:  $O(n)$ , for recursive stack.

*Non recursive* version of the above algorithm can be given as:

```
struct BinarySearchTreeNode *FindMin(struct BinarySearchTreeNode * root ) {
    if( root == NULL )
        return NULL;
    while( root->left != NULL )
        root = root->left;
    return root;
}
```

Time Complexity:  $O(n)$ . Space Complexity:  $O(1)$ .

### Finding Maximum Element in Binary Search Trees

In BSTs, the maximum element is the right most node which does not has right child. In the below BST, the maximum element is 16.

```
struct BinarySearchTreeNode *FindMax(struct BinarySearchTreeNode *root) {
    if(root == NULL)
        return NULL;
    else    if( root->right == NULL )
            return root;
            else return FindMax( root->right );
}
```

Time Complexity:  $O(n)$ , in worst case (when BST is a *right skew* tree). Space Complexity:  $O(n)$ , for recursive stack.

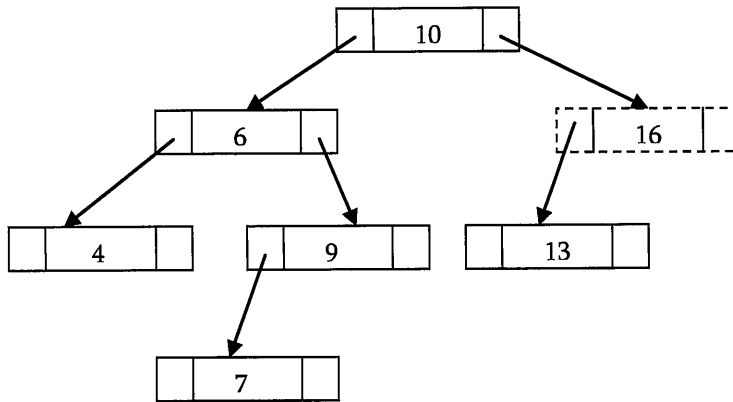

*Non recursive* version of the above algorithm can be given as:

```

struct BinarySearchTreeNode *FindMax(struct BinarySearchTreeNode * root ) {
    if( root == NULL )
        return NULL;
    while( root->right != NULL )
        root = root->right;
    return root;
}
  
```

Time Complexity:  $O(n)$ . Space Complexity:  $O(1)$ .

### Where is Inorder Predecessor and Successor?

Where is the inorder predecessor and successor of a node  $X$  in a binary search tree assuming all keys are distinct?

If  $X$  has two children then its inorder predecessor is the maximum value in its left subtree and its inorder successor the minimum value in its right subtree.

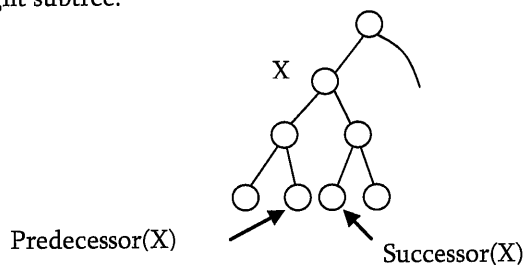

If it does not have a left child a nodes inorder predecessor is its first left ancestor.

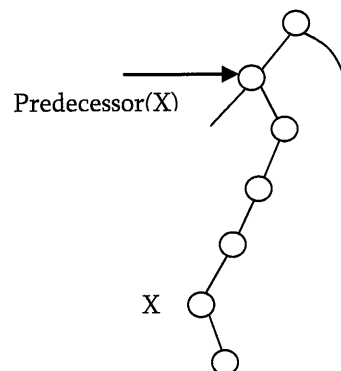

## Inserting an Element from Binary Search Tree

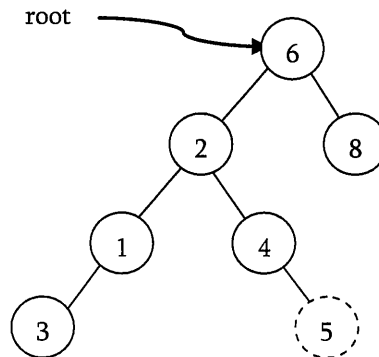

To insert *data* into binary search tree, first we need to find the location for that element. We can find the location of insertion by following the same mechanism as that of *find* operation. While finding the location if the *data* is already there then we can simply neglect and come out. Otherwise, insert *data* at the last location on the path traversed. As an example let us consider the following tree. The dotted node indicates the element (5) to be inserted. To insert 5, traverse the tree as using *find* function. At node with key 4, we need to go right, but there is no subtree, so 5 is not in the tree, and this is the correct location for insertion.

```

struct BinarySearchTreeNode *Insert(struct BinarySearchTreeNode *root, int data) {
    if( root == NULL ) {
        root = (struct BinarySearchTreeNode *) malloc(sizeof(struct BinarySearchTreeNode));
        if( root == NULL ) {
            printf("Memory Error");
            return;
        }
        else {
            root->data = data;
            root->left = root->right = NULL;
        }
    }
    else {
        if( data < root->data )
            root->left = Insert(root->left, data);
        else if( data > root->data )
            root->right = Insert(root->right, data);
    }
    return root;
}
  
```

**Note:** In the above code, after inserting an element in subtrees the tree is returned to its parent. As a result, the complete tree will get updated.

Time Complexity: $O(n)$ . Space Complexity: $O(n)$ , for recursive stack. For iterative version, space complexity is  $O(1)$ .

## Deleting an Element from Binary Search Tree

The delete operation is little complicated than other operations. This is because the element to be deleted may not be the leaf node. In this operation also, first we need to find the location of the element which we want to delete. Once we have found the node to be deleted, consider the following cases:

- If the element to be deleted is a leaf node: return NULL to its parent. That means make the corresponding child pointer NULL. In the below tree to delete 5, set NULL to its parent node 2.

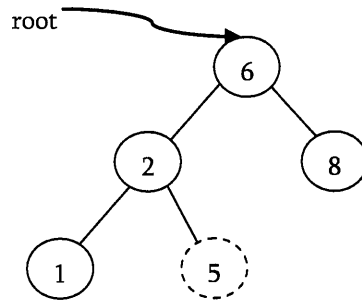

- If the element to be deleted has one child: In this case we just need to send the current nodes child to its parent. In the below tree, to delete 4, 4 left subtree is set to its parent node 2.

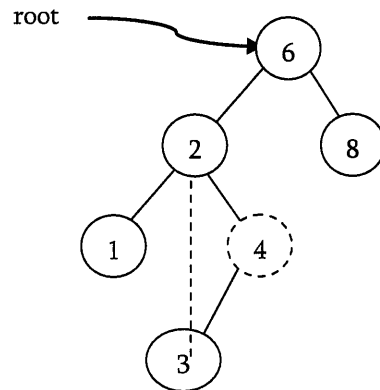

- If the element to be deleted has both children: The general strategy is to replace the key of this node with the largest element of the left subtree and recursively delete that node (which is now empty). The largest node in the left subtree cannot have a right child, the second *delete* is an easy one. As an example, let us consider the following tree. In the below tree, to delete 8, it is the right child of root. The key value is 8. It is replaced with the largest key in its left subtree (7), and then that node is deleted as before (second case).

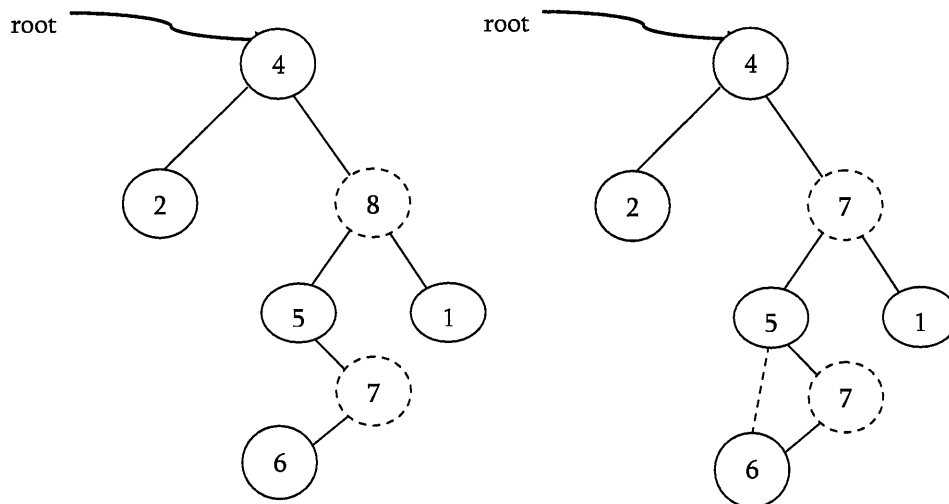

**Note:** We can replace with minimum element in right subtree also.

```
struct BinarySearchTreeNode *Delete(struct BinarySearchTreeNode *root, int data) {
    struct BinarySearchTreeNode *temp;
    if( root == NULL )
        printf("Element not there in tree");
    else if(data < root->element )
        root->left = Delete(root->left, data);
```

```

else if(data > root->element )
    root->right = Delete(root->right, data);
else { //Found element
    if( root->left && root->right ) {
        /* Replace with largest in left subtree */
        temp = FindMax( root->left );
        root->data = temp->element;
        root->left = Delete(root->left, root->data);
    }
    else { /* One child */
        temp = root;
        if( root->left == NULL )
            root = root->right;
        if( root->right == NULL )
            root = root->left;
        free( temp );
    }
}
return root;
}

```

Time Complexity:  $O(n)$ . Space Complexity:  $O(n)$  for recursive stack. For iterative version, space complexity is  $O(1)$ .

## Problems on Binary Search Trees

**Problem-46** Given pointers to two nodes in a binary search tree, find lowest common ancestor (LCA). Assume that both values already exist in the tree.

**Solution:**

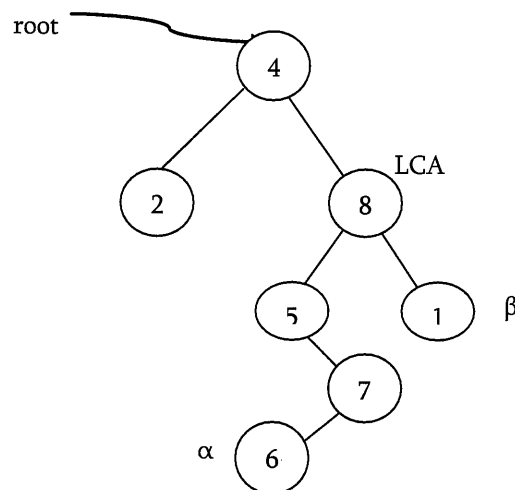

The main idea of the solution is: while traversing BST from root to bottom, the first node we encounter with value between  $\alpha$  and  $\beta$ , i.e.,  $\alpha < node \rightarrow data < \beta$  is the Least Common Ancestor(LCA) of  $\alpha$  and  $\beta$  (where  $\alpha < \beta$ ). So just traverse the BST in pre-order, if we find a node with value in between  $\alpha$  and  $\beta$  then that node is the LCA. If its value is greater than both  $\alpha$  and  $\beta$  then LCA lies on left side of the node and if its value is smaller than both  $\alpha$  and  $\beta$  then LCA lies on right side.

```

struct BinarySearchTreeNode *FindLCA(struct BinarySearchTreeNode *root,
                                     struct BinarySearchTreeNode *alpha, struct BinarySearchTreeNode *beta) {
    while(1) {
        if((alpha->data < root->data && beta->data > root->data) ||

```

```

        (α→data > root→data && β→data < root→data))
    return root;
    if(α→data < root→data)
        root = root→left;
    else    root = root→right;
}
}

```

Time complexity:  $O(n)$ . Space complexity:  $O(n)$ , for skew trees.

**Problem-47** Give an algorithm for finding the shortest path between two nodes in a BST.

**Solution:** It's nothing but finding the LCA of two nodes in BST.

**Problem-48** Give an algorithm for counting the number of BSTs possible with  $n$  nodes.

**Solution:** This is a DP problem and refer *Dynamic Programming* chapter for algorithm.

**Problem-49** Give an algorithm to check whether the given binary tree is a BST or not.

**Solution:** Consider the following simple program. For each node, check if left node of it is smaller than the node and right node of it is greater than the node. This approach is wrong as this will return true for below binary tree. Checking only at current node is not enough.

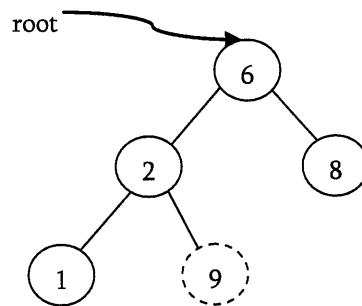

```

int IsBST(struct BinaryTreeNode* root) {
    if(root == NULL) return 1;
    /* false if left is > than root */
    if(root→left != NULL && root→left→data > root→data)
        return 0;
    /* false if right is < than root */
    if(root→right != NULL && root→right→data < root→data)
        return 0;
    /* false if, recursively, the left or right is not a BST */
    if(!IsBST(root→left) || !IsBST(root→right))
        return 0;
    /* passing all that, it's a BST */
    return 1;
}

```

**Problem-50** Can we think of getting the correct algorithm?

**Solution:** For each node, check if max value in left subtree is smaller than the current node data and min value in right subtree greater than the node data. It is assumed that we have helper functions *FindMin()* and *FindMax()* that return the min or max integer value from a non-empty tree.

```

/* Returns true if a binary tree is a binary search tree */
int IsBST(struct BinaryTreeNode* root) {
    if(root == NULL) return 1;

```



```

/* false if the max of the left is > than root */
if(root->left != NULL && FindMax(root->left) > root->data)
    return 0;
/* false if the min of the right is <= than root */
if(root->right != NULL && FindMin(root->right) < root->data)
    return 0;
/* false if, recursively, the left or right is not a BST */
if(!IsBST(root->left) || !IsBST(root->right)) return 0;
/* passing all that, it's a BST */
return 1;
}

```

Time complexity:  $O(n^2)$ . Space Complexity:  $O(n)$ .

**Problem-51** Can we improve the complexity of Problem-50?

**Solution:** Yes. A better solution looks at each node only once. The trick is to write a utility helper function `IsBSTUtil(struct BinaryTreeNode* root, int min, int max)` that traverses down the tree keeping track of the narrowing min and max allowed values as it goes, looking at each node only once. The initial values for min and max should be `INT_MIN` and `INT_MAX` — they narrow from there.

Initial call: `IsBST(root, INT_MIN, INT_MAX);`

```

int IsBST(struct BinaryTreeNode *root, int min, int max) {
    if(!root) return 1;
    return (root->data > min && root->data < max &&
            IsBSTUtil(root->left, min, root->data) && IsBSTUtil(root->right, root->data, max));
}

```

Time Complexity:  $O(n)$ . Space Complexity:  $O(n)$ , for stack space.

**Problem-52** Can we further improve the complexity of Problem-50?

**Solution:** Yes, using inorder traversal. The idea behind this solution is that, inorder traversal of BST produces sorted lists. While traversing the BST in inorder, at each node check the condition that its key value should be greater than the key value of its previous visited node. Also, we need to initialize the prev with possible minimum integer value (say, `INT_MIN`).

```

int prev = INT_MIN;
int IsBST(struct BinaryTreeNode *root, int *prev) {
    if(!root) return 1;
    if(!IsBST(root->left, prev))
        return 0;
    if(root->data < *prev)
        return 0;
    *prev = root->data;
    return IsBST(root->right, prev);
}

```

Time Complexity:  $O(n)$ . Space Complexity:  $O(n)$ , for stack space.

**Problem-53** Give an algorithm for converting BST to circular DLL with space complexity  $O(1)$ .

**Solution:** Convert left and right subtrees to DLLs and maintain end of those lists. Then, adjust the pointers.

```

struct BinarySearchTreeNode *BST2DLL(struct BinarySearchTreeNode *root, struct BinarySearchTreeNode **Ltail) {
    struct BinarySearchTreeNode *left, *ltail, *right, *rtail;
    if(!root) {
        *Ltail = NULL;
    }
}

```

```

        return NULL;
    }
    left = BST2DLL(root->left, &ltail);
    right = BST2DLL(root->right, &rtail);
    root->left = ltail;
    root->right = right;
    if(!right)
        *ltail = root;
    else {
        right->left = root;
        *ltail = rtail;
    }
    if(!left)
        return root;
    else {
        ltail->right = root;
        return left;
    }
}

```

Time Complexity:  $O(n)$ .

**Problem-54** For Problem-53, is there any other way of solving?

**Solution: Yes.** There is an alternative solution based on divide and conquer method which is quite neat.

```

struct BinarySearchTreeNode *Append(struct BinarySearchTreeNode *a, struct BinarySearchTreeNode *b) {
    struct BinarySearchTreeNode *aLast, *bLast;
    if (a==NULL)
        return b;
    if (b==NULL)
        return a;
    aLast = a->left;
    bLast = b->left;
    aLast->right = b;
    b->left = aLast;
    bLast->right = a;
    a->left = bLast;
    return a;
}
struct BinarySearchTreeNode* TreeToList(struct BinarySearchTreeNode *root) {
    struct BinarySearchTreeNode *aList, *bList;
    if (root==NULL)
        return NULL;
    aList = TreeToList(root->left);
    bList = TreeToList(root->right);
    root->left = root;
    root->right = root;
    aList = Append(aList, root);
    aList = Append(aList, bList);
    return(aList);
}

```

Time Complexity:  $O(n)$ .

**Problem-55** Given a sorted doubly linked list, give an algorithm for converting it to balanced binary search tree.

**Solution:** Find the middle node and adjust the pointers.

```
struct DLLNode * DLLtoBalancedBST(struct DLLNode *head) {
    struct DLLNode *temp, *p, *q;
    if( !head || !head->next)
        return head;
    temp = FindMiddleNode(head);
    p = head;
    while(p->next != temp)
        p = p->next;
    p->next = NULL;
    q = temp->next;
    temp->next = NULL;
    temp->prev = DLLtoBalancedBST(head);
    temp->next = DLLtoBalancedBST(q);
    return temp;
}
```

Time Complexity:  $2T(n/2) + O(n)$  [for finding the middle node] =  $O(n \log n)$ .

**Note:** For *FindMiddleNode* function refer *Linked Lists* chapter.

**Problem-56** Given a sorted array, give an algorithm for converting the array to BST.

**Solution:** If we have to choose an array element to be the root of a balanced BST, which element we should pick? The root of a balanced BST should be the middle element from the sorted array. We would pick the middle element from the sorted array in each iteration. We then create a node in the tree initialized with this element. After the element is chosen, what is left? Could you identify the sub-problems within the problem?

There are two arrays left — The one on its left and the one on its right. These two arrays are the sub-problems of the original problem, since both of them are sorted. Furthermore, they are subtrees of the current node's left and right child.

The code below creates a balanced BST from the sorted array in  $O(n)$  time ( $n$  is the number of elements in the array). Compare how similar the code is to a binary search algorithm. Both are using the divide and conquer methodology.

```
struct BinaryTreeNode *BuildBST(int A[], int left, int right) {
    struct BinaryTreeNode *newNode;
    int mid;
    if(left > right)
        return NULL;
    newNode = (struct BinaryTreeNode *)malloc(sizeof(struct BinaryTreeNode));
    if(!newNode) {
        printf("Memory Error");
        return;
    }
    if(left == right) {
        newNode->data = A[left];
        newNode->left = newNode->right = NULL;
    }
    else {
        mid = left + (right-left)/ 2;
        newNode->data = A[mid];
        newNode->left = BuildBST(A, left, mid - 1);
        newNode->right = BuildBST(A, mid + 1, right);
    }
    return newNode;
}
```

```
}
Time Complexity:  $O(n)$ . Space Complexity:  $O(n)$ , for stack space.
```

**Problem-57** Given a singly linked list where elements are sorted in ascending order, convert it to a height balanced BST.

**Solution:** A naive way is to apply the Problem-55 solution directly. In each recursive call, we would have to traverse half of the list's length to find the middle element. The run time complexity is clearly  $O(n \log n)$ , where  $n$  is the total number of elements in the list. This is because each level of recursive call requires a total of  $n/2$  traversal steps in the list, and there are a total of  $\log n$  number of levels (ie, the height of the balanced tree).

**Problem-58** For Problem-57, can we improve the complexity?

**Solution: Hint:** How about inserting nodes following the list's order? If we can achieve this, we no longer need to find the middle element, as we are able to traverse the list while inserting nodes to the tree.

**Best Solution:** As usual, the best solution requires us to think from another perspective. In other words, we no longer create nodes in the tree using the top-down approach. Create nodes bottom-up, and assign them to its parents. The bottom-up approach enables us to access the list in its order while creating nodes [42].

Isn't the bottom-up approach neat? Each time we are stucked with the top-down approach, give bottom-up a try. Although bottom-up approach is not the most natural way we think, it is extremely helpful in some cases. However, we should prefer top-down instead of bottom-up in general, since the latter is more difficult to verify in correctness.

Below is the code for converting a singly linked list to a balanced BST. Please note that the algorithm requires the list's length to be passed in as the function's parameters. The list's length could be found in  $O(n)$  time by traversing the entire list's once. The recursive calls traverse the list and create tree's nodes by the list's order, which also takes  $O(n)$  time. Therefore, the overall run time complexity is still  $O(n)$ .

```
struct BinaryTreeNode* SortedListToBST(struct ListNode *&list, int start, int end) {
    if(start > end)
        return NULL;
    // same as (start+end)/2, avoids overflow
    int mid = start + (end - start) / 2;
    struct BinaryTreeNode *leftChild = SortedListToBST(list, start, mid-1);
    struct BinaryTreeNode *parent;
    parent = (struct BinaryTreeNode *)malloc(sizeof(struct BinaryTreeNode));
    if(!parent) {
        printf("Memory Error");
        return;
    }
    parent->data=list->data;
    parent->left = leftChild;
    list = list->next;
    parent->right = SortedListToBST(list, mid+1, end);
    return parent;
}
struct BinaryTreeNode * SortedListToBST(struct ListNode *head, int n) {
    return SortedListToBST(head, 0, n-1);
}
```

**Problem-59** Give an algorithm for finding the  $k^{th}$  smallest element in BST.

**Solution:** The idea behind this solution is that, inorder traversal of BST produces sorted lists. While traversing the BST in inorder, keep track of the number of elements visited.

```

struct BinarySearchTreeNode *kthSmallestInBST(struct BinarySearchTreeNode *root, int k, int *count){
    if(!root) return NULL;
    struct BinarySearchTreeNode *left = kthSmallestInBST(root->left, k, count);
    if( left ) return left;
    if(++count == k)
        return root;
    return kthSmallestInBST(root->right, k, count);
}

```

Time Complexity:  $O(n)$ . Space Complexity:  $O(1)$ .

**Problem-60 Floor and ceiling:** If a given key is less than the key at the root of a BST then floor of key (the largest key in the BST less than or equal to key) must be in the left subtree. If key is greater than the key at the root then floor of key could be in the right subtree, but only if there is a key smaller than or equal to key in the right subtree; if not (or if key is equal to the key at the root) then the key at the root is the floor of key. Finding the ceiling is similar with interchanging right and left. For example, if the sorted with input array is {1, 2, 8, 10, 10, 12, 19}, then

For  $x = 0$ : floor doesn't exist in array, ceil = 1, For  $x = 1$ : floor = 1, ceil = 1

For  $x = 5$ : floor = 2, ceil = 8, For  $x = 20$ : floor = 19, ceil doesn't exist in array

**Solution:** The idea behind this solution is that, inorder traversal of BST produces sorted lists. While traversing the BST in inorder, keep track of the values being visited. If the roots data is greater than the given value then return the previous value which we have maintained during traversal. If the roots data is equal to the given data then return root data.

```

struct BinaryTreeNode *FloorInBST(struct BinaryTreeNode *root, int data){
    struct BinaryTreeNode *prev=NULL;
    return FloorInBSTUtil(root, prev, data);
}
struct BinaryTreeNode *FloorInBSTUtil(struct BinaryTreeNode *root, struct BinaryTreeNode *prev, int data){
    if(!root)
        return NULL;
    if(!FloorInBSTUtil(root->left, prev, data))
        return 0;
    if(root->data == data)
        return root;
    if(root->data > data)
        return prev;
    prev = root;
    return FloorInBSTUtil(root->right, prev, data);
}

```

Time Complexity:  $O(n)$ . Space Complexity:  $O(n)$ , for stack space.

For ceiling, we just need to call the right subtree first and then followed by left subtree.

```

struct BinaryTreeNode *CeilingInBST(struct BinaryTreeNode *root, int data){
    struct BinaryTreeNode *prev=NULL;
    return CeilingInBSTUtil(root, prev, data);
}
struct BinaryTreeNode *CeilingInBSTUtil(struct BinaryTreeNode *root, struct BinaryTreeNode *prev, int data){
    if(!root)
        return NULL;
    if(!CeilingInBSTUtil(root->right, prev, data))
        return 0;
    if(root->data == data) return root;
}

```

```

    if(root->data < data) return prev;
    prev = root;
    return CeilingInBSTUtil(root->left, prev, data);
}

```

Time Complexity:  $O(n)$ . Space Complexity:  $O(n)$ , for stack space.

**Problem-61** Give an algorithm for finding the union and intersection of BSTs. Assume parent pointers are available (say threaded binary trees). Also, assume the lengths of two BSTs are  $m$  and  $n$  respectively.

**Solution:** If parent pointers are available then the problem is same as merging of two sorted lists. This is because if we call inorder successor each time we get the next highest element. It's just a matter of which InorderSuccessor to call.

Time Complexity:  $O(m + n)$ . Space complexity:  $O(1)$ .

**Problem-62** For Problem-61, what if parent pointers are not available?

**Solution:** If parent pointers are not available then, one possibility is converting the BSTs to linked lists and then merging.

- 1 Convert both the BSTs into sorted doubly linked lists in  $O(n + m)$  time. This produces 2 sorted lists.
- 2 Merge the two double linked lists into one and also maintain the count of total elements in  $O(n + m)$  time.
- 3 Convert the sorted doubly linked list into height balanced tree in  $O(n + m)$  time.

**Problem-63** For Problem-61, is there any alternative way of solving the problem?

**Solution:** Yes, using inorder traversal.

- Perform inorder traversal on one of the BST.
- While performing the traversal store them in table (hash table).
- After completion of the traversal of first *BST*, start traversal of the second *BST* and compare them with hash table contents.

Time Complexity:  $O(m + n)$ . Space Complexity:  $O(\text{Max}(m, n))$ .

**Problem-64** Given a *BST* and two numbers  $K1$  and  $K2$ , give an algorithm for printing all the elements of *BST* in the range  $K1$  and  $K2$ .

**Solution:**

```

void RangePrinter(struct BinarySearchTreeNode *root, int K1, int K2) {
    if(root == NULL)
        return;
    if(root->data >= K1)
        RangePrinter(root->left, K1, K2);
    if(root->data >= K1 && root->data <= K2)
        printf("%d", root->data);
    if(root->data <= K2)
        RangePrinter(root->right, K1, K2);
}

```

Time Complexity:  $O(n)$ . Space Complexity:  $O(n)$ , for stack space.

**Problem-65** For Problem-64, is there any alternative way of solving the problem?

**Solution:** We can use level order traversal: while adding the elements to queue check for the range.

```

void RangeSeachLevelOrder(struct BinarySearchTreeNode *root, int K1, int K2){
    struct BinarySearchTreeNode *temp;
    struct Queue *Q = CreateQueue();
    if(!root)
        return NULL;
    Q = EnQueue(Q, root);
}

```

```

while(!IsEmptyQueue(Q)) {
    temp=DeQueue(Q);
    if(temp->data >= K1 && temp->data <= K2)
        printf("%d",temp->data);
    if(temp->left && temp->data >= K1)
        EnQueue(Q, temp->left);
    if(temp->right && temp->data <= K2)
        EnQueue(Q, temp->right);
}
DeleteQueue(Q);
return NULL;
}

```

Time Complexity:  $O(n)$ . Space Complexity:  $O(n)$ , for queue.

**Problem-66** For Problem-64, can we still think of alternative way for solving the problem?

**Solution:** First locate  $K1$  with normal binary search and after that use InOrder successor until we encounter  $K2$ . For algorithm, refer problems section of threaded binary trees.

**Problem-67** Given root of a Binary Search tree, trim the tree, so that all elements in the new tree returned are between the inputs  $A$  and  $B$ .

**Solution:** It's just another way of asking the Problem-64.

**Problem-68** Given two BSTs, check whether the elements of them are same or not. For example: two BSTs with data 10 5 20 15 30 and 10 20 15 30 5 should return true and the dataset with 10 5 20 15 30 and 10 15 30 20 5 should return false. **Note:** BSTs data can be in any order.

**Solution:** One simple way is performing a traversal on first tree and storing its data in hash table. As a second step perform traversal on second tree and check whether that data is already there in hash table or not. During the traversal of second tree if we find any mismatch return false.

Time Complexity:  $O(\max(m, n))$ , where  $m$  and  $n$  are the number of elements in first and second BST. Space Complexity:  $O(\max(m, n))$ . This depends on the size of the first tree.

**Problem-69** For Problem-68, can we reduce the time complexity?

**Solution:** Instead of performing the traversals one after the other, we can perform *in-order* traversal of both the trees in parallel. Since the *in-order* traversal gives the sorted list, we can check whether both the trees are generating the same sequence or not.

Time Complexity:  $O(\max(m, n))$ . Space Complexity:  $O(1)$ . This depends on the size of the first tree.

**Problem-70** For the key values  $1 \dots n$ , how many structurally unique BSTs are possible that store those keys.

**Solution:** Strategy: consider that each value could be the root. Recursively find the size of the left and right subtrees.

```

int CountTrees(int n) {
    if (n <= 1) return 1;
    else { // there will be one value at the root, with whatever remains on the left and right
        // each forming their own subtrees. Iterate through all the values that could be the root...
        int sum = 0;
        int left, right, root;
        for (root=1; root<=n; root++) {
            left = CountTrees(root - 1);
            right = CountTrees(numKeys - root);
            // number of possible trees with this root == left*right
            sum += left*right;
        }
    }
}

```

```

    }
    return(sum);
}
}

```

## 6.12 Balanced Binary Search Trees

In earlier sections we have seen different trees whose worst case complexity is  $O(n)$ , where  $n$  is the number of nodes in the tree. This happens when the trees are skew trees. In this section we will try to reduce this worst case complexity to  $O(\log n)$  by imposing restrictions on the heights. In general, the height balanced trees are represented with  $HB(k)$ , where  $k$  is the difference between left subtree height and right subtree height. Sometimes  $k$  is called balance factor.

### Complete Balanced Binary Search Trees

In  $HB(k)$ , if  $k = 0$  (if balance factor is zero), then we call such binary search trees as *full* balanced binary search trees. That means, in  $HB(0)$  binary search tree, the difference between left subtree height and right subtree height should be at most zero. This ensures that the tree is a full binary tree. For example,

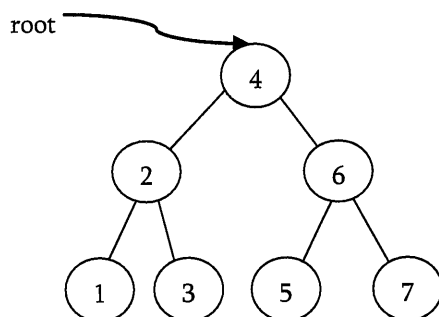

**Note:** For constructing  $HB(0)$  tree refer problems section.

## 6.13 AVL (Adelson-Velskii and Landis) Trees

In  $HB(k)$ , if  $k = 1$  (if balance factor is one), such binary search tree is called an AVL tree. That means an AVL tree is a binary search tree with a *balance* condition: the difference between left subtree height and right subtree height is at most 1.

### Properties of AVL Trees

A binary tree is said to be an AVL tree, if:

- It is a binary search tree, and
- For any node  $X$ , the height of left subtree of  $X$  and height of right subtree of  $X$  differ by at most 1.

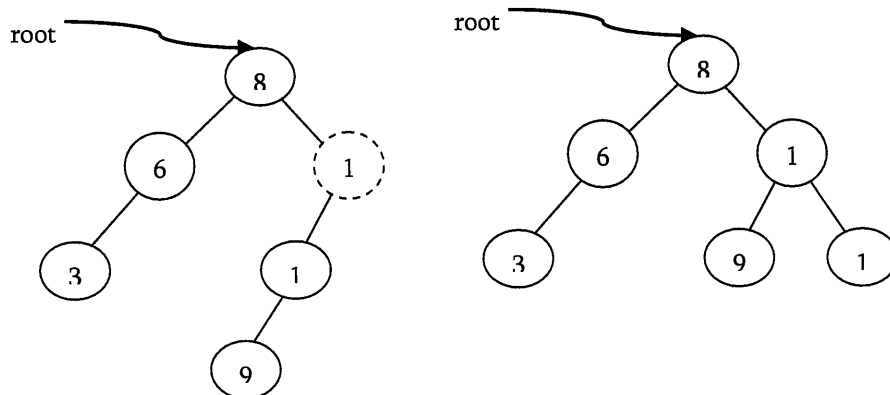

As an example among the above binary search trees, the left one is not an AVL tree, whereas the right binary search tree is an AVL tree.



## Minimum/Maximum Number of Nodes in AVL Tree

For simplicity let us assume that the height of an AVL tree is  $h$  and  $N(h)$  indicates the number of nodes in AVL tree with height  $h$ . To get minimum number of nodes with height  $h$ , we should fill the tree with as minimum nodes as possible. That means if we fill the left subtree with height  $h - 1$  then we should fill the right subtree with height  $h - 2$ . As a result, the minimum number of nodes with height  $h$  is:

$$N(h) = N(h - 1) + N(h - 2) + 1$$

In the above equation:

- $N(h - 1)$  indicates the minimum number of nodes with height  $h - 1$ .
- $N(h - 2)$  indicates the minimum number of nodes with height  $h - 2$ .
- In the above expression, "1" indicates the current node.

We can give  $N(h - 1)$  either for left subtree or right subtree. Solving the above recurrence gives:

$$N(h) = O(1.618^h) \Rightarrow h = 1.44 \log n \approx O(\log n)$$

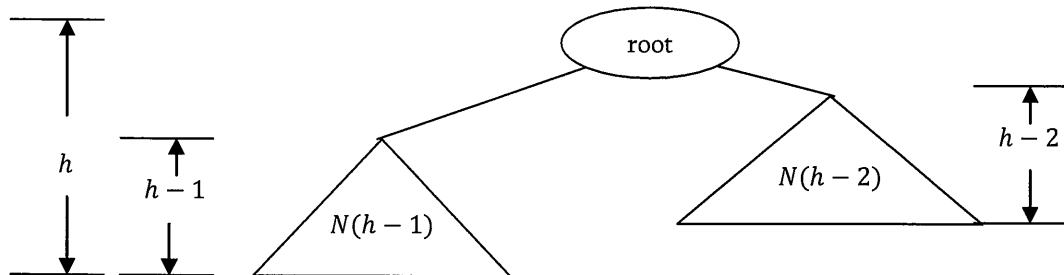

Where  $n$  is the number of nodes in AVL tree. Also, the above derivation says that the maximum height in AVL trees is  $O(\log n)$ . Similarly, to get maximum number of nodes, we need to fill both left and right subtrees with height  $h - 1$ . As a result, we get

$$N(h) = N(h - 1) + N(h - 1) + 1 = 2N(h - 1) + 1$$

The above expression defines the case of full binary tree. Solving the recurrence we get:

$$N(h) = O(2^h) \Rightarrow h = \log n \approx O(\log n)$$

∴ In both the cases, AVL tree property is ensuring that the height of an AVL tree with  $n$  nodes is  $O(\log n)$ .

## AVL Tree Declaration

Since AVL tree is a BST, the declaration of AVL is similar to that of BST. But just to simplify the operations, we include the height also as part of declaration.

```
struct AVLTreeNode{
    struct AVLTreeNode *left;
    int data;
    struct AVLTreeNode *right;
    int height;
};
```

## Finding Height of an AVL tree

```
int Height(struct AVLTreeNode *root ){
    if( !root) return -1;
    else return root->height;
}
```

Time Complexity:  $O(1)$ .

## Rotations

When the tree structure changes (e.g., with insertion or deletion), we need to modify the tree to restore the AVL tree property. This can be done using single rotations or double rotations. Since an insertion/deletion involves

adding/deleting a single node, this can only increase/decrease the height of some subtree by 1. So, if the AVL tree property is violated at a node  $X$ , it means that the heights of  $\text{left}(X)$  and  $\text{right}(X)$  differ by exactly 2. This is because, if we balance the AVL tree every time, then at any point, the difference in heights of  $\text{left}(X)$  and  $\text{right}(X)$  differ by exactly 2. Rotations is the technique used for restoring the AVL tree property. That means, we need to apply the rotations for the node  $X$ .

**Observation:** One important observation is that, after an insertion, only nodes that are on the path from the insertion point to the root might have their balances altered because only those nodes have their subtrees altered. To restore the AVL tree property, we start at the insertion point and keep going to root of the tree. While moving to root, we need to consider the first node whichever is not satisfying the AVL property. From that node onwards every node on the path to root will have the issue. Also, if we fix the issue for that first node, then all other nodes on the path to root will automatically satisfy the AVL tree property. That means we always need to care for the first node whichever is not satisfying the AVL property on the path from insertion point to root and fix it.

## Types of Violations

Let us assume the node that must be rebalanced is  $X$ . Since any node has at most two children, and a height imbalance requires that  $X$ 's two subtrees' heights differ by two. We can easily observe that a violation might occur in four cases:

1. An insertion into the left subtree of the left child of  $X$ .
2. An insertion into the right subtree of the left child of  $X$ .
3. An insertion into the left subtree of the right child of  $X$ .
4. An insertion into the right subtree of the right child of  $X$ .

Cases 1 and 4 are symmetric and easily solved with single rotations. Similarly, cases 2 and 3 are also symmetric and can be solved with double rotations (needs two single rotations).

## Single Rotations

**Left Left Rotation (LL Rotation) [Case-1]:** In the below case, at node  $X$ , the AVL tree property is not satisfying. As discussed earlier, rotation does not have to be done at the root of a tree. In general, we start at the node inserted and travel up the tree, updating the balance information at every node on the path.

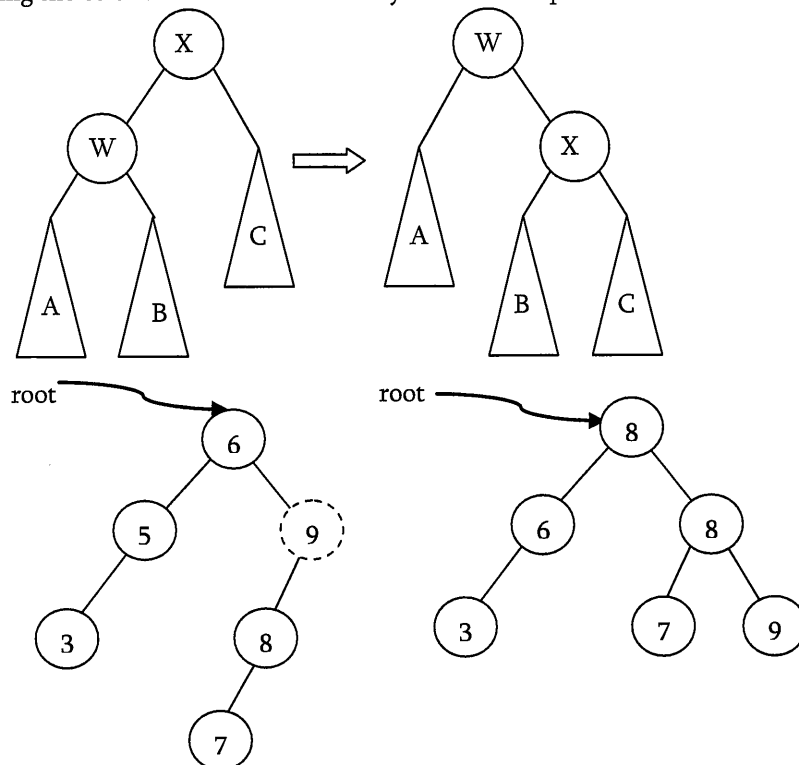

For example, in above figure, after the insertion of 7 in the original AVL tree on the left, node 9 becomes unbalanced. So, we do a single left-left rotation at 9. As a result we get the tree on the right.

```
struct AVLTreeNode *SingleRotateLeft(struct AVLTreeNode *X){
    struct AVLTreeNode *W = X->left;
    X->left = W->right;
    W->right = X;
    X->height = max( Height(X->left), Height(X->right) ) + 1;
    W->height = max( Height(W->left), X->height ) + 1;
    return W; /* New root */
}
```

Time Complexity:  $O(1)$ . Space Complexity:  $O(1)$ .

**Right Right Rotation (RR Rotation) [Case-4]:** In this case, the node  $X$  is not satisfying the AVL tree property.

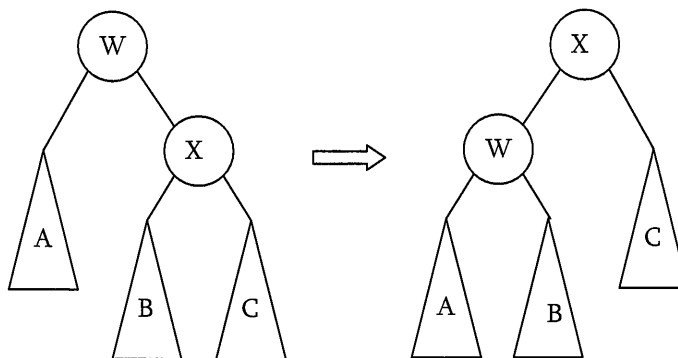

For example, in above figure, after the insertion of 29 in the original AVL tree on the left, node 15 becomes unbalanced. So, we do a single right-right rotation at 15. As a result we get the tree on the right.

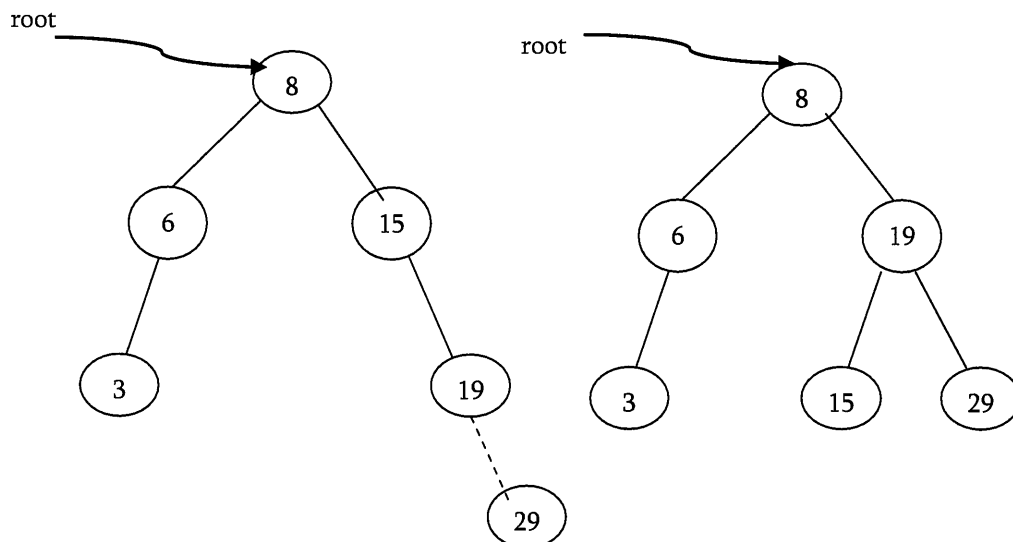

```
struct AVLTreeNode *SingleRotateRight(struct AVLTreeNode *W) {
    struct AVLTreeNode *X = W->right;
    W->right = X->left;
    X->left = W;
    W->height = max( Height(W->right), Height(W->left) ) + 1;
    X->height = max( Height(X->right), W->height ) + 1;
    return X;
}
```

}  
 Time Complexity:  $O(1)$ . Space Complexity:  $O(1)$ .

### Double Rotations

**Left Right Rotation (LR Rotation) [Case-2]:** For case-2 and case-3 single rotation does not fix the problem. We need to perform two rotations.

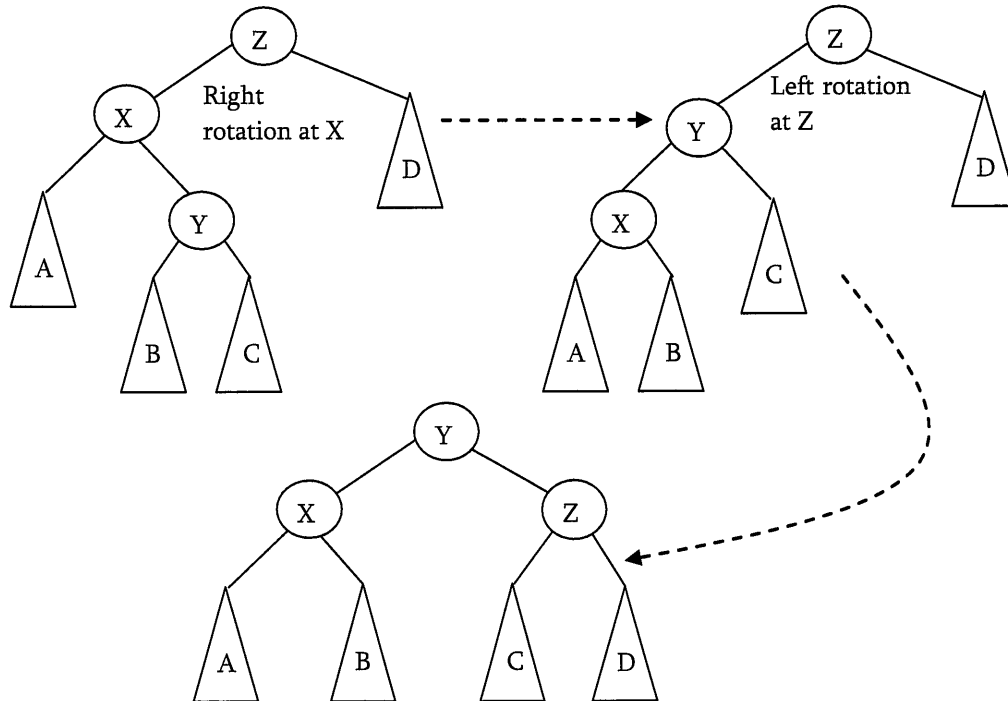

As an example, let us consider the following tree: Insertion of 7 is creating the case-2 scenario and right side tree is the one after double rotation.

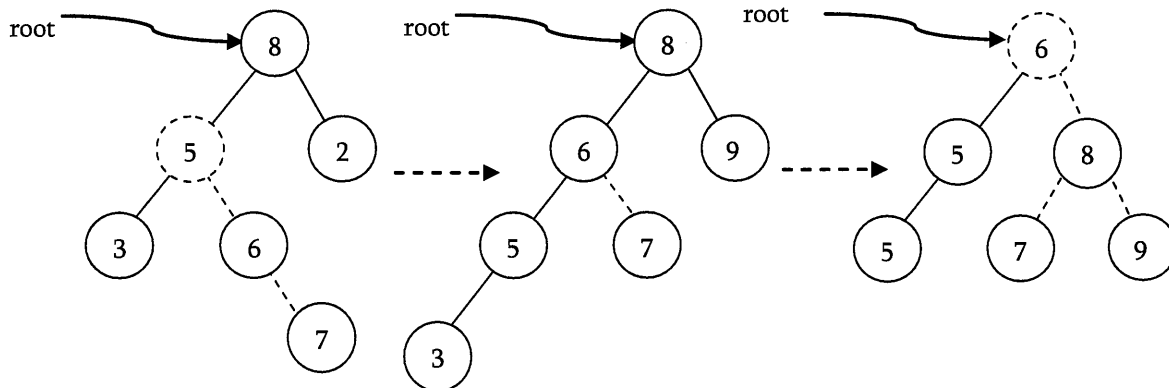

Code for left-right double rotation can be given as:

```
struct AVLTreeNode *DoubleRotatewithLeft( struct AVLTreeNode *Z){
    Z->left = SingleRotateRight( Z->left );
    return SingleRotateLeft(Z);
}
```

**Right Left Rotation (RL Rotation) [Case-3]:** As similar to case-2, we need to perform two rotations for fixing this scenario.

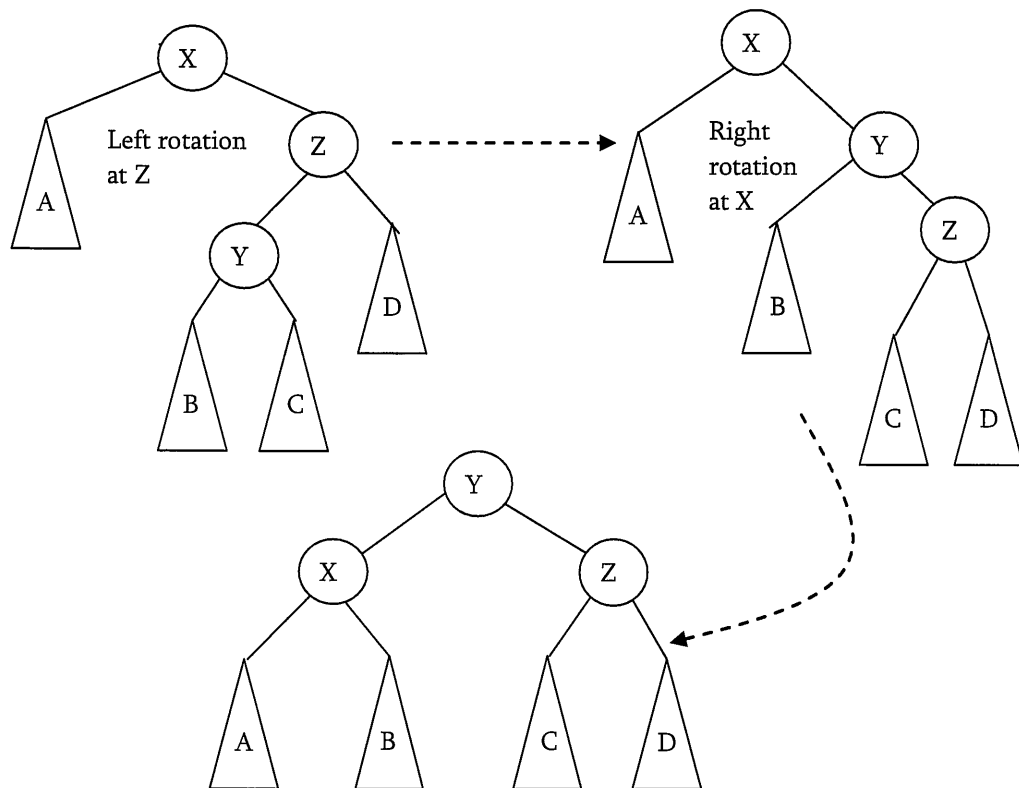

As an example, let us consider the following tree: Insertion of 6 is creating the case-3 scenario and right side tree is the one after double rotation.

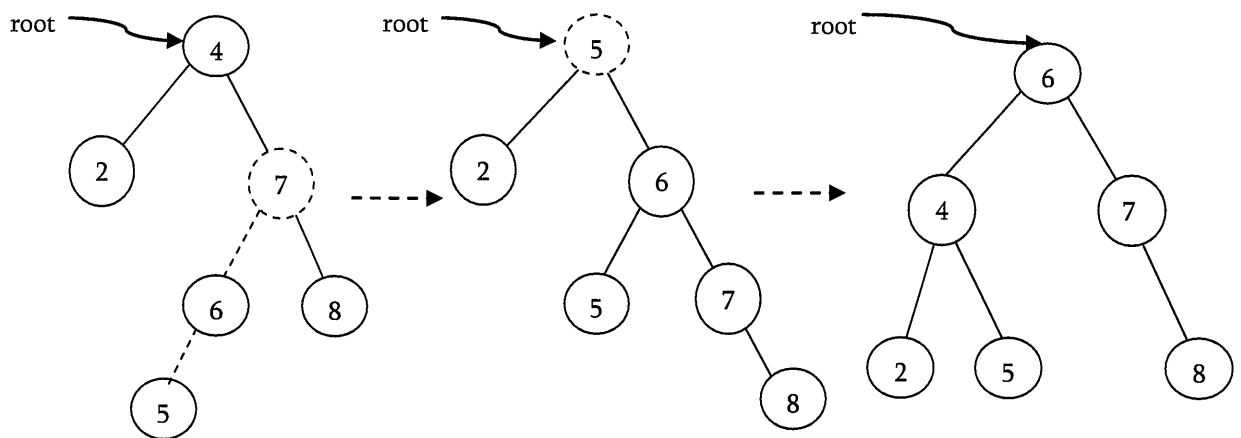

### Insertion into an AVL tree

Insertion in AVL tree is very much similar to BST insertion. After inserting the element, we just need to check whether there is any height imbalance. If there is any imbalance, call the appropriate rotation functions.

```
struct AVLTreeNode *Insert( struct AVLTreeNode *root, struct AVLTreeNode *parent, int data){
    if( !root) {
        root = (struct AVLTreeNode*) malloc(sizeof (struct AVLTreeNode* ));
        if(!root) { printf("Memory Error");
            return;
        }
    }
    else {
        root->data = data;
        root->height = 0;
        root->left = root->right = NULL;
    }
}
```

```

    }
}
else if( data < root->data ) {
    root->left = Insert( root->left, root, data );
    if( ( Height( root->left ) - Height( root->right ) ) == 2 ) {
        if( data < root->left->data )
            root = SingleRotateLeft( root );
        else
            root = DoubleRotateLeft( root );
    }
}
else if( data > root->data ) {
    root->right = Insert( root->right, root, data );
    if( ( Height( root->right ) - Height( root->left ) ) == 2 ) {
        if( data < root->right->data )
            root = SingleRotateRight( root );
        else
            root = DoubleRotateRight( root );
    }
}
/* Else data is in the tree already. We'll do nothing */
root->height = max( Height(root->left), Height(root->right) ) + 1;
return root;
}

```

Time Complexity:  $O(n)$ . Space Complexity:  $O(\log n)$ .

## Problems on AVL Trees

**Problem-71** Given a height  $h$ , give an algorithm for generating the  $HB(0)$ .

**Solution:** As we have discussed,  $HB(0)$  is nothing but generating full binary tree. In full binary tree the number of nodes with height  $h$  are:  $2^{h+1} - 1$  (let us assume that the height of a tree with one node is 0). As a result the nodes can be numbered as: 1 to  $2^{h+1} - 1$ .

```

struct BinarySearchTreeNode *BuildHB0(int h){
    struct BinarySearchTreeNode *temp;
    if(h == 0)
        return NULL;
    temp = (struct BinarySearchTreeNode *) malloc (sizeof(struct BinarySearchTreeNode));
    temp->left = BuildHB0 (h-1);
    temp->data = count++; //assume count is a global variable
    temp->right = BuildHB0 (h-1);
    return temp;
}

```

Time Complexity:  $O(n)$ . Space Complexity:  $O(\log n)$ , where  $\log n$  indicates the maximum stack size which is equal to height of tree.

**Problem-72** Is there any alternative way of solving Problem-71?

**Solution:** Yes, we can solve following Mergesort logic. That means, instead of working with height, we can take the range. With this approach we do not need any global counter to be maintained.

```

Struct BinarySearchTreeNode *BuildHB0(int l, int r){
    struct BinarySearchTreeNode *temp;
    int mid = l +  $\frac{r-l}{2}$ ;
}

```

```

if( l > r)
    return NULL;
temp = (struct BinarySearchTreeNode *) malloc (sizeof(struct BinarySearchTreeNode));
temp->data = mid;
temp->left = BuildHB0(l, mid-1);
temp->right = BuildHB0(mid+1, r);
return temp;
}
    
```

The initial call to *BuildHB0* function could be: *BuildHB0*(1, 1 << *h*). 1 << *h* does the shift operation for calculating the  $2^{h+1} - 1$ .

Time Complexity:  $O(n)$ . Space Complexity:  $O(\log n)$ . Where  $\log n$  indicates maximum stack size which is equal to height of the tree.

**Problem-73** Construct minimal AVL trees of height 0, 1, 2, 3, 4, and 5. What is the number of nodes in a minimal AVL tree of height 6?

**Solution** Let  $N(h)$  be the number of nodes in a minimal AVL tree with height  $h$ .

$$N(0) = 1$$

$$N(1) = 2$$

$$N(h) = 1 + N(h - 1) + N(h - 2)$$

$$N(2) = 1 + N(1) + N(0) = 1 + 2 + 1 = 4$$

$$N(3) = 1 + N(2) + N(1) = 1 + 4 + 2 = 7$$

$$N(4) = 1 + N(3) + N(2) = 1 + 7 + 4 = 12$$

$$N(5) = 1 + N(4) + N(3) = 1 + 12 + 7 = 20$$

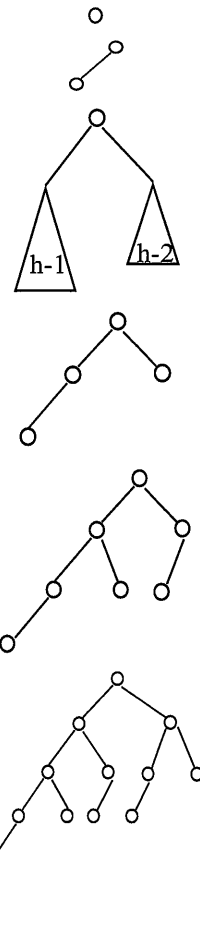

**Problem-74** For the Problem-71 how many different shapes of a minimal AVL tree of height  $h$  can have?

**Solution:** Let  $NS(h)$  be the number of different shapes of a minimal AVL tree of height  $h$ .

$$NS(0) = 1$$

$$NS(1) = 2$$

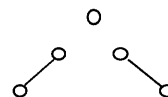

$$NS(2) = 2 * NS(1) * NS(0) \\ = 2 * 2 * 1 = 4$$

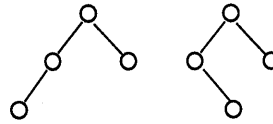

$$NS(3) = 2 * NS(2) * NS(1) \\ = 2 * 4 * 1 = 8$$

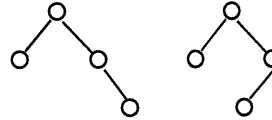

...

$$NS(h) = 2 * NS(h-1) * NS(h-2)$$

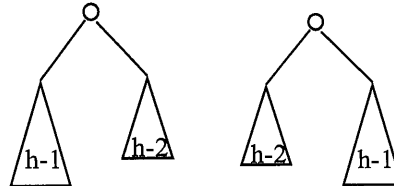

**Problem-75** Given a binary search tree check whether the tree is an AVL tree or not?

**Solution:** Let us assume that *IsAVL* is the function which checks whether the given binary search tree is an AVL tree or not. *IsAVL* returns  $-1$  if the tree is not an AVL tree. During the checks each node sends height of it to their parent.

```
int IsAVL(struct BinarySearchTreeNode *root){
    int left, right;
    if(!root)
        return 0;
    left = IsAVL(root->left);
    if(left == -1)
        return left;
    right = IsAVL(root->right);
    if(right == -1)
        return right;
    if(abs(left-right)>1)
        return -1;
    return Max(left, right)+1;
}
```

Time Complexity:  $O(n)$ . Space Complexity:  $O(n)$ .

**Problem-76** Given a height  $h$ , give an algorithm to generate an AVL tree with min number of nodes.

**Solution:** To get minimum number of nodes, fill one level with  $h-1$  and other with  $h-2$ .

```
struct AVLTreeNode *GenerateAVLTree(int h){
    struct AVLTreeNode *temp;
    if(h == 0)
        return NULL;
    temp = (struct AVLTreeNode *)malloc (sizeof(struct AVLTreeNode));
    temp->left = GenerateAVLTree(h-1);
    temp->data = count++; //assume count is a global variable
    temp->right = GenerateAVLTree(h-2);
    temp->height = temp->left->height+1; // or temp->height = h;
    return temp;
}
```

**Problem-77** Given an AVL tree with  $n$  integer items and two integers  $a$  and  $b$ , where  $a$  and  $b$  can be any integers with  $a \leq b$ . Implement an algorithm to count the number of nodes in the range  $[a, b]$ .



Solution:

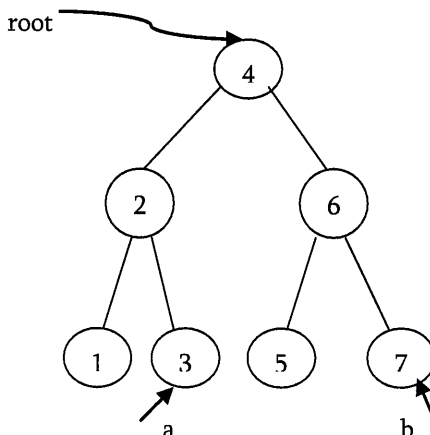

The idea is to make use of the recursive property of binary search trees. There are three cases to consider, whether the current node is in the range  $[a, b]$ , on the left side of the range  $[a, b]$  or on the right side of the range  $[a, b]$ . Only subtrees that possibly contain the nodes will be processed under each of the three cases.

```

int RangeCount(struct AVLNode *root, int a, int b) {
    if(root == NULL)
        return 0;
    else if(root->data > b)
        return RangeCount(curr->left, a, b);
    else if(root->data < a)
        return RangeCount(root->right, a, b);
    else if(root->data >= a && root->data <= b)
        return RangeCount(root->left, a, b) + RangeCount(root->right, a, b) + 1;
}
  
```

The complexity is similar to *in-order* traversal of the tree but skipping left or right sub-trees when they do not contain any answers. So in the worst case, if the range covers all the nodes in the tree, we need to traverse all the  $n$  nodes to get the answer. The worst time complexity is therefore  $O(n)$ .

If the range is small, which only covers few elements in a small subtree at the bottom of the tree, the time complexity will be  $O(h) = O(\log n)$ , where  $h$  is the height of the tree. This is because only a single path is traversed to reach the small subtree at the bottom and many higher level subtrees have been pruned along the way.

**Note:** Refer similar problem in BST.

## 6.14 Other Variations in Trees

In this section, let us enumerate the other possible representations of trees. In the earlier sections, we have seen AVL trees which is a binary search tree (BST) with balancing property. Now, let us see few more balanced binary search trees: Red-Black Trees and Splay Trees.

### Red-Black Trees

In red-black trees each node is associated with extra attribute: the color, which is either red or black. To get logarithmic complexity we impose the following restrictions.

**Definition:** A red-black tree is a binary search tree that satisfies the following properties:

- Root Property: the root is black
- External Property: every leaf is black
- Internal Property: the children of a red node are black
- Depth Property: all the leaves have the same black

As similar to AVL trees, if the Red-black tree becomes imbalanced then we perform rotations to reinforce the balancing property. With Red-black trees, we can perform the following operations in  $O(\log n)$  in worst case, where  $n$  is the number of nodes in the trees.

- Insertion, Deletion
- Finding predecessor, successor
- Finding minimum, maximum

## Splay Trees

Splay-trees are BSTs with self-adjusting property. Another interesting property of splay-trees is: starting with empty tree, any sequence of  $K$  operations with maximum of  $n$  nodes takes  $O(K \log n)$  time complexity in worst case.

Splay trees are easier to program and also ensures faster access to recently accessed items. As similar to AVL and Red-Black trees, at any point if the splay tree becomes imbalanced then we perform rotations to reinforce the balancing property.

Splay-trees cannot guarantee the  $O(\log n)$  complexity in worst case. But it gives amortized  $O(\log n)$  complexity. Even though individual operations can be expensive, any sequence of operations gets the complexity of logarithmic behavior. One operation may take more time (a single operation may take  $O(n)$  time) but the subsequent operations may not take worst case complexity and on the average *per operation* complexity is  $O(\log n)$ .

## Augmented Trees

In earlier sections, we have seen the problems like finding  $K^{th}$  –smallest element in the tree and many other similar problems. For all those problems the worst complexity is  $O(n)$ , where  $n$  is the number of nodes in the tree. To perform such operations in  $O(\log n)$  augmented trees are useful. In these trees, extra information is added to each node and that extra data depends on the problem we are trying to solve. For example, to find  $K^{th}$  –smallest in binary search tree, let us see how augmented trees solves the problem. Let us assume that we are using Red-Black trees as balanced BST (or any balanced BST) and augment the size information in the nodes data. For a given node  $X$  in Red-Black tree with a field  $size(X)$  equal to the number of nodes in the subtree and can be calculated as:

$$size(X) = size(X \rightarrow left) + size(X \rightarrow right) + 1$$

**Example:** With the extra size information, the augmented tree will look like:

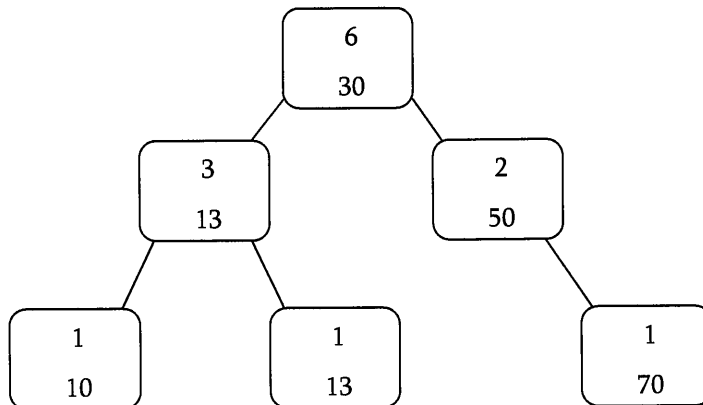

Kth-smallest operation can be defined as:

```

struct BinarySearchTreeNode *KthSmallest (struct BinarySearchTreeNode *X, int K) {
    int r = size(X->left) + 1;
    if(K == r)
        return X;
    if(K < r)
        return KthSmallest (X->left, K);
    if(K > r)

```

```

return KthSmallest (X→right, K-r);
}
Time Complexity:  $O(\log n)$ . Space Complexity:  $O(\log n)$ .

```

### Interval Trees

Interval trees are also binary search trees and stores interval information in the node structure. That means, we maintain a set of  $n$  intervals  $[i_1, i_2]$  such that one of the intervals containing a query point  $Q$  (if any) can be found efficiently. Interval trees are used for performing range queries efficiently.

**Example:** Given a set of intervals:  $S = \{[2-5], [6-7], [6-10], [8-9], [12-15], [15-23], [25-30]\}$ . A query with  $Q = 9$  returns  $[6, 10]$  or  $[8, 9]$  (assume these are the intervals which contains 9 among all the intervals). A query with  $Q = 23$  returns  $[15, 23]$ .

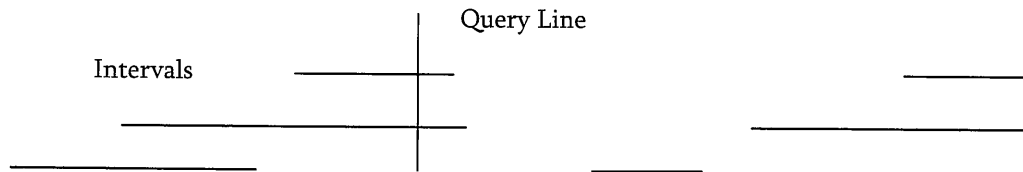

**Construction of Interval Trees:** Let us assume that we are given a set  $S$  of  $n$  intervals (also called segments). These  $n$  intervals will have  $2n$  endpoints. Now, let us see how to construct the interval tree.

**Algorithm:**

Recursively build tree on interval set  $S$  as follows:

- Sort the  $2n$  endpoints
- Let  $X_{mid}$  be the median point

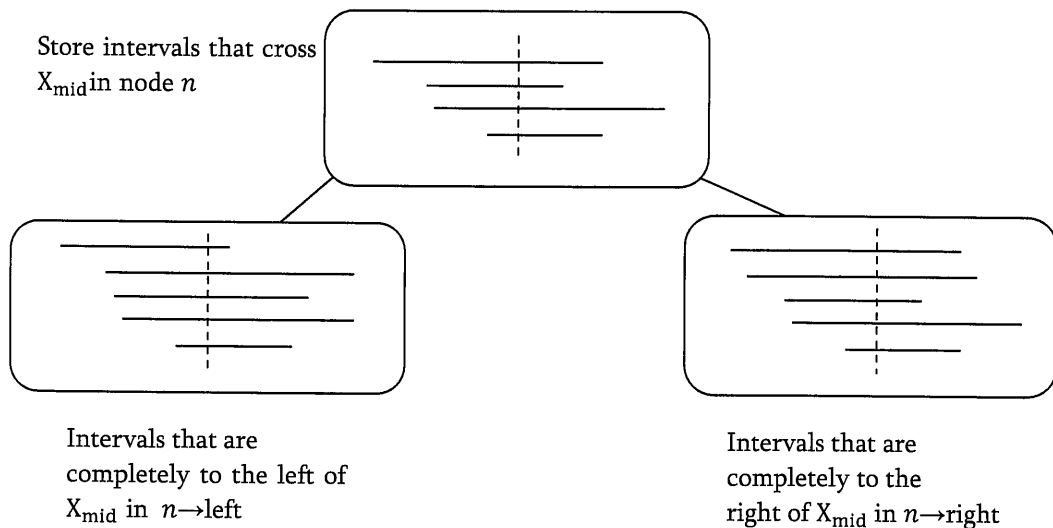

Time Complexity for building interval trees:  $O(n \log n)$ . Since we are choosing the median, Interval Trees will be approximately balanced. This ensures that, we split the set of end points up in half each time. The depth of the tree is  $O(\log n)$ . To simplify the search process, generally  $X_{mid}$  is stored with each node.