

LINKED LISTS

Chapter-3



3.1 What is a Linked List?

Linked list is a data structure used for storing collections of data. Linked list has the following properties.

- Successive elements are connected by pointers
- Last element points to NULL
- Can grow or shrink in size during execution of a program
- Can be made just as long as required (until systems memory exhausts)
- It does not waste memory space (but takes some extra memory for pointers)

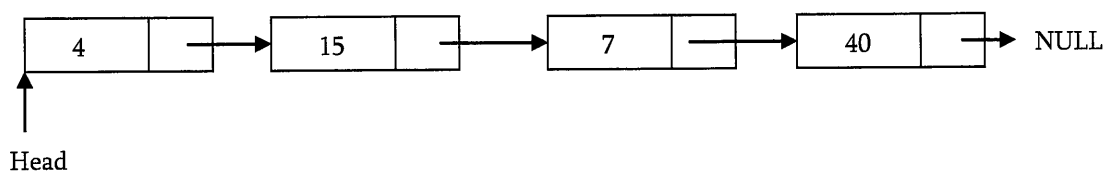

3.2 Linked Lists ADT

The following operations make linked lists an ADT.

Main Linked Lists Operations

- Insert: inserts an element into the list
- Delete: removes and returns the specified position element from the list

Auxiliary Linked Lists Operations

- Delete List: removes all elements of the list (disposes the list)
- Count: returns the number of elements in the list
- Find n^{th} node from the end of the list etc...

3.3 Why Linked Lists?

There are many other data structures which do the same thing as that of linked lists. Before discussing linked lists it is important to understand the difference between linked lists and arrays. Both linked lists and arrays are used to store collections of data. Since both are used for the same purpose, we need to differentiate the usage of them. That means in which cases *arrays* are suitable and in which cases *linked lists* are suitable.

3.4 Arrays Overview

One memory block is allocated for the entire array to hold the elements of the array. The array elements can be accessed in a constant time by using the index of the particular element as the subscript.

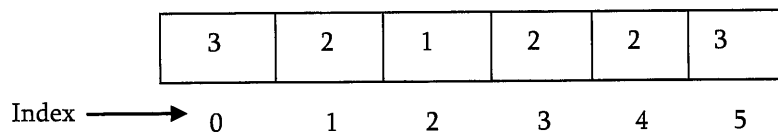

Why Constant Time for Accessing Array Elements?

To access an array element, address of an element is computed as an offset from the base address of the array and one multiplication is needed to compute what is supposed to be added to the base address to get the memory address of the element. First the size of an element of that data type is calculated and then it is multiplied with the index of the element to get the value to be added to the base address.

This process takes one multiplication and one addition. Since these two operations take constant time, we can say the array access can be performed in constant time.

Advantages of Arrays

- Simple and easy to use
- Faster access to the elements (constant access)

Disadvantages of Arrays

- **Fixed size:** The size of the array is static (specify the array size before using it).
- **One block allocation:** To allocate the array at the beginning itself, sometimes it may not be possible to get the memory for the complete array (if the array size is big).
- **Complex position-based insertion:** To insert an element at a given position then we may need to shift the existing elements. This will create a position for us to insert the new element at the desired position. If the position at which we want to add an element is at the beginning then the shifting operation is more expensive.

Dynamic Arrays

Dynamic array (also called as *growable array*, *resizable array*, *dynamic table*, or *array list*) is a random access, variable-size list data structure that allows elements to be added or removed.

One simple way of implementing dynamic arrays is, initially start with some fixed size array. As soon as that array becomes full, create the new array of size double than the original array. Similarly, reduce the array size to half if the elements in the array are less than half.

Note: We will see the implementation for *dynamic arrays* in *Stacks*, *Queues* and *Hashing* chapters.

Advantages of Linked Lists

Linked lists have advantages and disadvantages. The advantage of linked lists is that they can be *expanded* in constant time. To create an array we must allocate memory for a certain number of elements. To add more elements to the array then we must create a new array and copy the old array into the new array. This can take lot of time.

We can prevent this by allocating lots of space initially but then you might allocate more than you need and wasting memory. With a linked list we can start with space for just one element allocated and *add* on new elements easily without the need to do any copying and reallocating.

Issues with Linked Lists (Disadvantages)

There are a number of issues in linked lists. The main disadvantage of linked lists is *access time* to individual elements. Array is random-access, which means it takes $O(1)$ to access any element in the array. Linked lists takes $O(n)$ for access to an element in the list in the worst case. Another advantage of arrays in access time is special *locality* in memory. Arrays are defined as contiguous blocks of memory, and so any array element will be physically near its neighbors. This greatly benefits from modern CPU caching methods.

Although the dynamic allocation of storage is a great advantage, the *overhead* with storing and retrieving data can make a big difference. Sometimes linked lists are *hard to manipulate*. If the last item is deleted, the last but one must

now have its pointer changed to hold a NULL reference. This requires that the list is traversed to find the last but one link, and its pointer set to a NULL reference. Finally, linked lists wastes memory in terms of extra reference points.

3.5 Comparison of Linked Lists with Arrays & Dynamic Arrays

Parameter	Linked list	Array	Dynamic array
Indexing	$O(n)$	$O(1)$	$O(1)$
Insertion/deletion at beginning	$O(1)$	-	$O(n)$
Insertion/deletion at ending	$O(n)$	-	$O(1)$, if the array is not full $O(n)$, if the array is full
Insertion/deletion in middle	$O(n)$	-	$O(n)$
Wasted space	$O(n)$	0	$O(n)$

3.6 Singly Linked Lists

Generally "linked list" means a singly linked list. This list consists of a number of nodes in which each node has a *next* pointer to the following element. The link of the last node in the list is NULL which indicates end of the list.

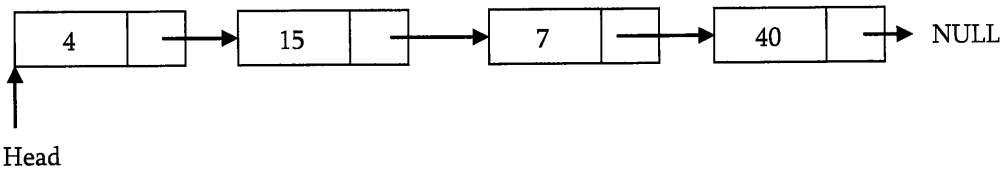

Following is a type declaration for a linked list of integers:

```

struct ListNode {
    int data;
    struct ListNode *next;
};
  
```

Basic Operations on a List

- Traversing the list
- Inserting an item in the list
- Deleting an item from the list

Traversing the Linked List

Let us assume that the *head* points to the first node of the list. To traverse the list we do the following.

- Follow the pointers.
- Display the contents of the nodes (or count) as they are traversed.
- Stop when the next pointer points to NULL.

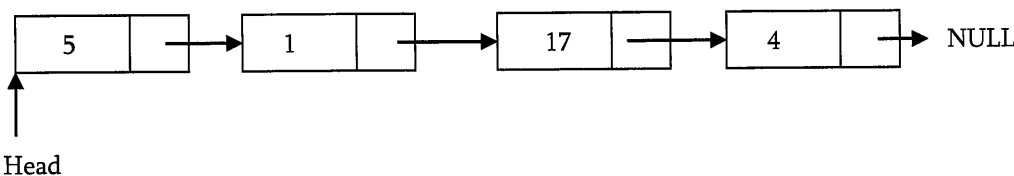

The `ListLength()` function takes a linked list as input and counts the number of nodes in the list. Below function can be used for printing the list data with extra print function.

```

int ListLength(struct ListNode *head) {
    struct ListNode *current = head;
    int count = 0;
  
```

```

while (current != NULL) {
    count++;
    current = current->next;
}
return count;
}

```

Time Complexity: $O(n)$, for scanning the complete list of size n . Space Complexity: $O(1)$, for creating one temporary variable.

Singly Linked List Insertion

Insertion into a singly-linked list has three cases:

- Inserting a new node before the head (at the beginning)
- Inserting a new node after the tail (at the end of the list)
- Inserting a new node at the middle of the list (random location)

Note: To insert an element in the linked list at some position p , assume that after inserting the element the position of this new node is p .

Inserting a Node in Singly Linked List at the Beginning

In this case, a new node is inserted before the current head node. *Only one next pointer* needs to be modified (new node's next pointer) and it can be done in two steps:

- Update the next pointer of new node, to point to the current head.

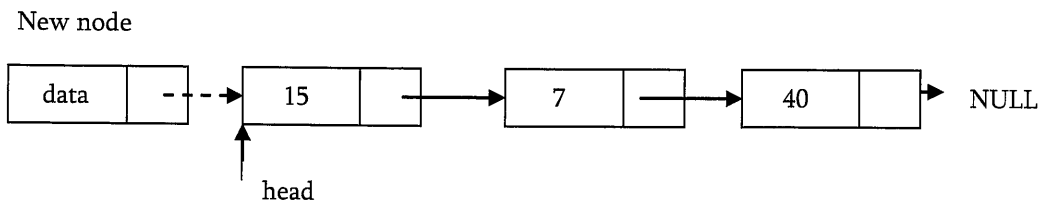

- Update head pointer to point to the new node.

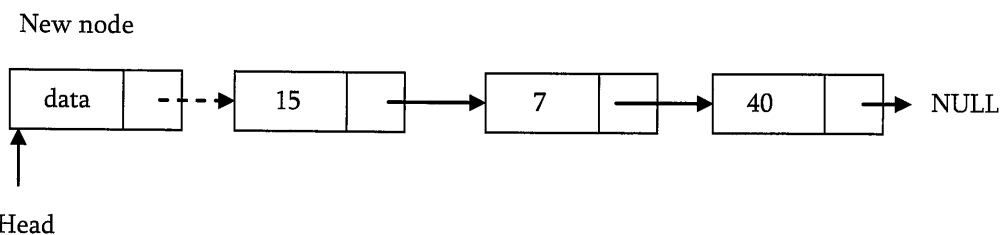

Inserting a Node in Singly Linked List at the Ending

In this case, we need to modify *two next pointers* (last nodes next pointer and new nodes next pointer).

- New nodes next pointer points to NULL.

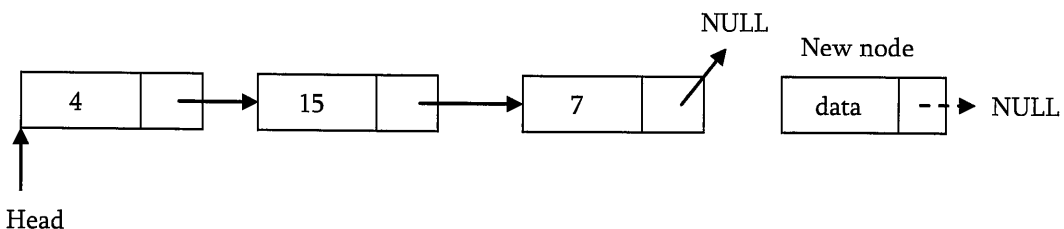

- Last nodes next pointer points to the new node.

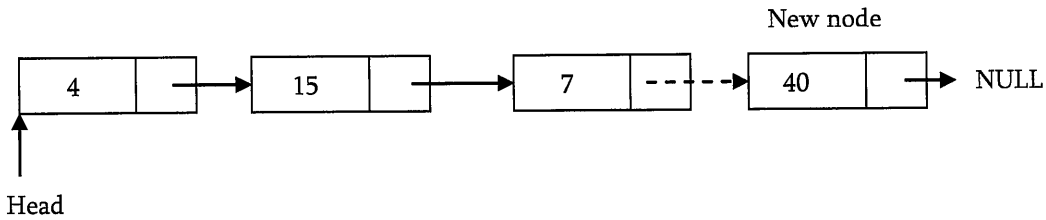

Inserting a Node in Singly Linked List at the Middle

Let us assume that we are given a position where we want to insert the new node. In this case also, we need to modify two next pointers.

- If we want to add an element at position 6 then we stop at position 5. That means we traverse 5 nodes and insert the new node. For simplicity let us assume that fifth is called *position* node. New node points to the next node of the position where we want to add this node.

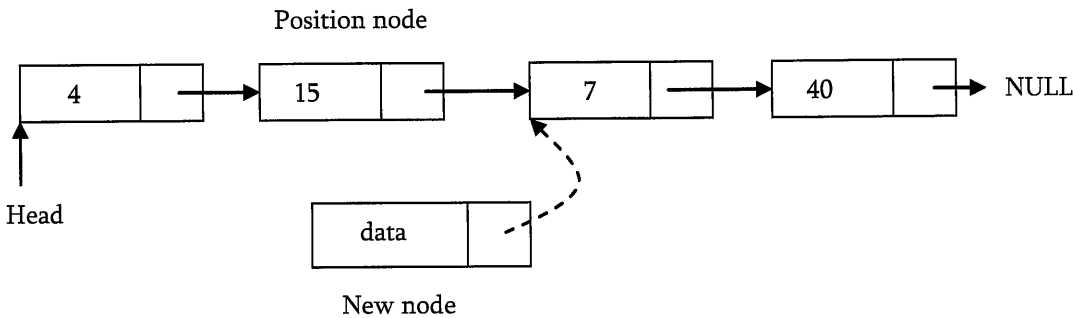

- Position nodes next pointer now points to the new node.

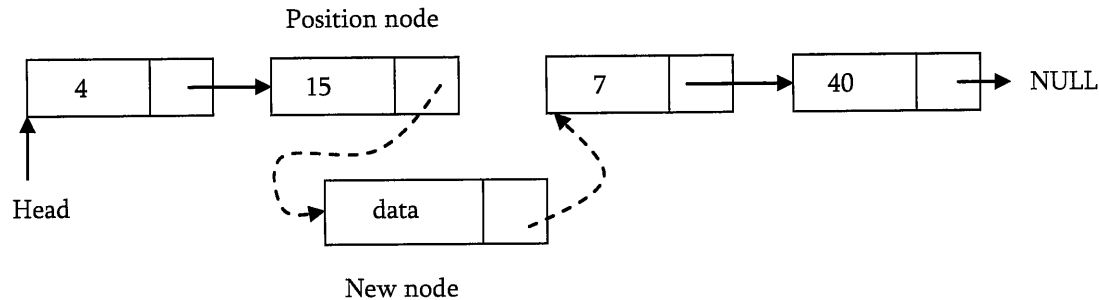

Let us write the code for all these three cases. We must update the first element pointer in the calling function, not just in the called function. For this reason we need to send double pointer. The following code inserts a node in the singly linked list.

```
void InsertInLinkedList (struct ListNode **head, int data, int position) {
    int k = 1;
    struct ListNode *p, *q, *newNode;
    newNode = (ListNode *) malloc(sizeof(struct ListNode));
    if(!newNode) {
        printf ("Memory Error");
        return;
    }
    newNode->data=data;
    p = *head;
    if(position == 1) {
        // Inserting at the beginning
        newNode->next = p;
        *head = newNode;
    }
}
```

```

else { //Traverse the list until position-1
    while ((p != NULL) && (k < position - 1)) {
        k++;
        q = p;
        p = p->next;
    }
    if(p == NULL) { //Inserting at the end
        q->next = newNode;
        newNode->next = NULL;
    }
    else { // In the middle
        q->next = newNode;
        newNode->next = p;
    }
}
}

```

Note: We can implement the three variations of the *insert* operation separately.

Time Complexity: $O(n)$. Since, in the worst we may need to insert the node at end of the list. Space Complexity: $O(1)$, for creating one temporary variable.

Singly Linked List Deletion

As similar to insertion here also we have three cases.

- Deleting the first node
- Deleting the last node
- Deleting an intermediate node

Deleting the First Node in Singly Linked List

First node (current head node) is removed from the list. It can be done in two steps:

- Create a temporary node which will point to same node as that of head.

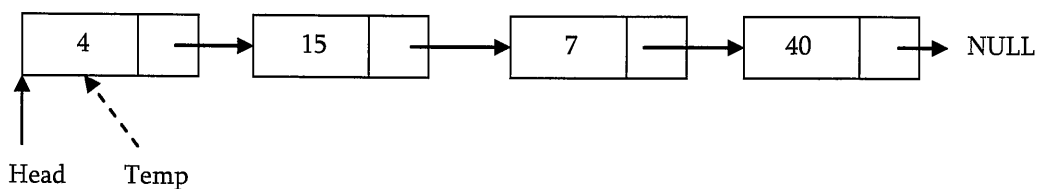

- Now, move the head nodes pointer to the next node and dispose the temporary node.

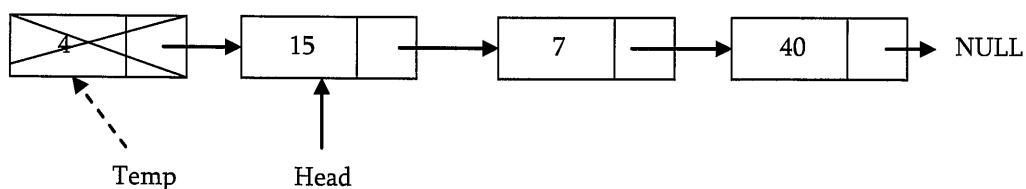

Deleting the last node in Singly Linked List

In this case, last node is removed from the list. This operation is a bit trickier than removing the first node, because algorithm should find a node, which is previous to the tail first. It can be done in three steps:

- Traverse the list and while traversing maintain the previous node address also. By the time we reach the end of list, we will have two pointers one pointing to the *tail* node and other pointing to the node *before* tail node.

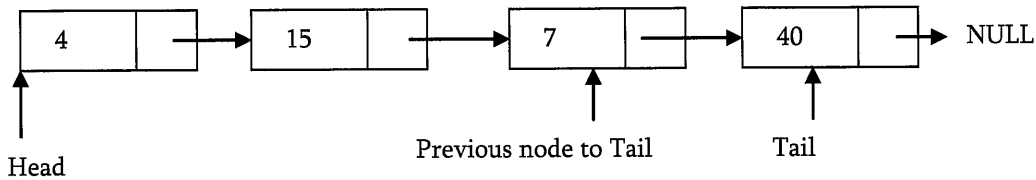

- Update previous nodes next pointer with NULL.

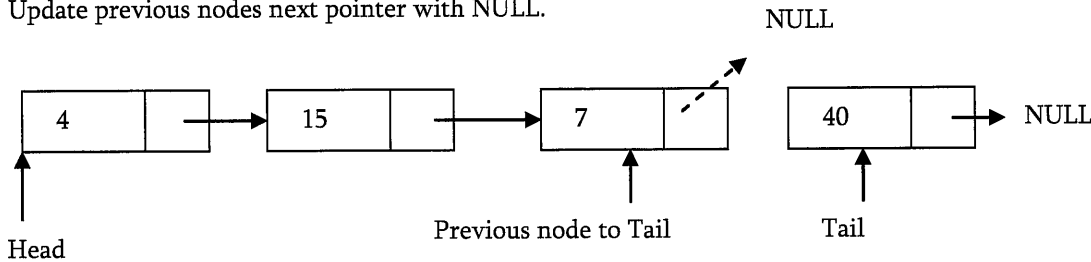

- Dispose the tail node.

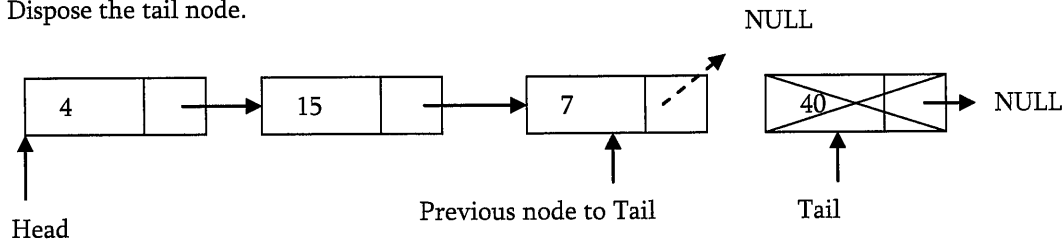

Deleting an Intermediate Node in Singly Linked List

In this case, node to be removed is *always located between* two nodes. Head and tail links are not updated in this case. Such a removal can be done in two steps:

- As similar to previous case, maintain previous node while traversing the list. Once we found the node to be deleted, change the previous nodes next pointer to next pointer of the node to be deleted.

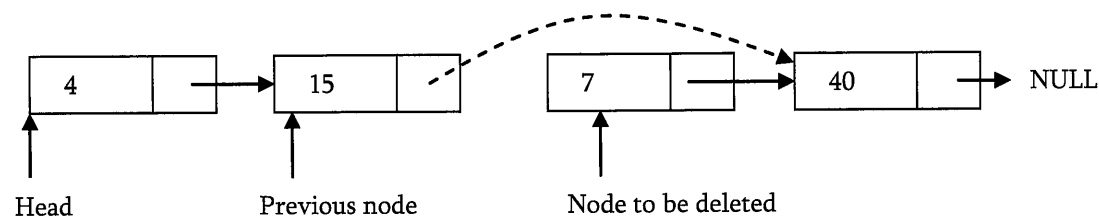

- Dispose the current node to be deleted.

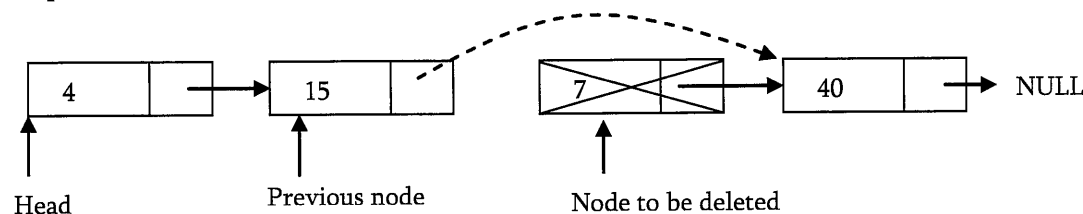

```
void DeleteNodeFromLinkedList (struct ListNode **head, int position) {
    int k = 1;
    struct ListNode *p, *q;
```

```

if(*head == NULL) {
    printf ("List Empty");
    return;
}
p = *head;
if(position == 1) {                /* from the beginning */
    p = *head;
    *head = *head->next;
    free (p); return;
}
else { //Traverse the list until the position from which we want to delete
    while ((p != NULL) && (k < position - 1)) {
        k++; q = p;
        p = p->next;
    }
    if(p == NULL)                  /* At the end */
        printf ("Position does not exist.");
    else {                          /* From the middle */
        q->next = p->next;
        free(p);
    }
}
}
}

```

Time Complexity: $O(n)$. In the worst we may need to delete the node at the end of the list. Space Complexity: $O(1)$. Since, we are creating only one temporary variable.

Deleting Singly Linked List

This works by storing the current node in some temporary variable and freeing the current node. After freeing the current node go to next node with temporary variable and repeat this process for all nodes.

```

void DeleteLinkedList(struct ListNode **head) {
    struct ListNode *auxiliaryNode, *iterator;
    iterator = *head;
    while (iterator) {
        auxiliaryNode = iterator->next;
        free(iterator);
        iterator = auxiliaryNode;
    }
    *head = NULL;                // to affect the real head back in the caller.
}

```

Time Complexity: $O(n)$, for scanning the complete list of size n . Space Complexity: $O(1)$, for creating one temporary variable.

3.7 Doubly Linked Lists

The *advantage* of a doubly linked list (also called *two – way linked list*) is given a node in the list, we can navigate in both directions. A node in a singly linked list cannot be removed unless we have the pointer to its predecessor. But in doubly linked list we can delete a node even if we don't have previous nodes address (since, each node has left pointer pointing to previous node and can move backward). The primary *disadvantages* of doubly linked lists are:

- Each node requires an extra pointer, requiring more space.

- The insertion or deletion of a node takes a bit longer (more pointer operations).

As similar to singly linked list, let us implement the operations of doubly linked lists. If you understand the singly linked list operations then doubly linked list operations are very obvious. Following is a type declaration for a doubly linked list of integers:

```
struct DLLNode {
    int data;
    struct DLLNode *next;
    struct DLLNode *prev;
};
```

Doubly Linked List Insertion

Insertion into a doubly-linked list has three cases (same as singly linked list):

- Inserting a new node before the head.
- Inserting a new node after the tail (at the end of the list).
- Inserting a new node at the middle of the list.

Inserting a Node in Doubly Linked List at the Beginning

In this case, new node is inserted before the head node. Previous and next pointers need to be modified and it can be done in two steps:

- Update the right pointer of new node to point to the current head node (dotted link in below figure) and also make left pointer of new node as NULL.

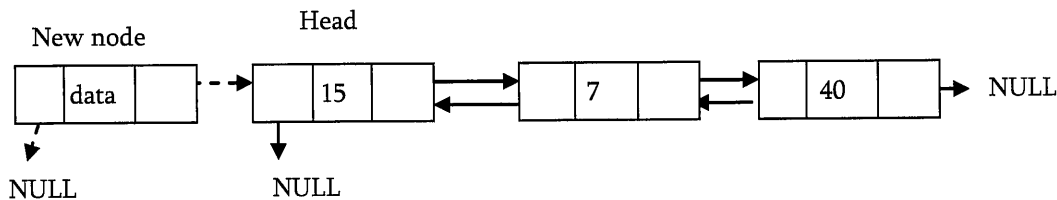

- Update head nodes left pointer to point to the new node and make new node as head.

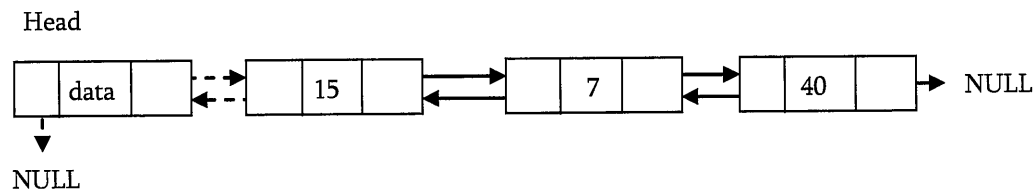

Inserting a Node in Doubly Linked List at the Ending

In this case, traverse the list till the end and insert the new node.

- New node right pointer points to NULL and left pointer points to the end of the list.

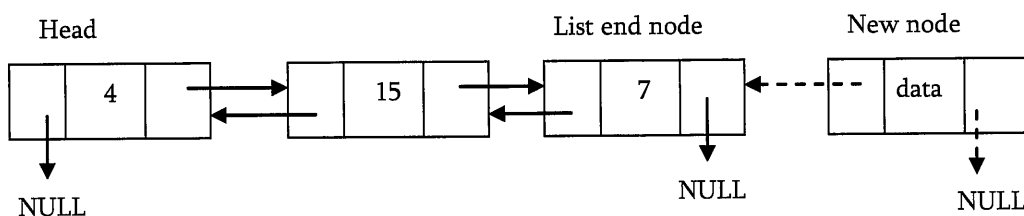

- Update right of pointer of last node to point to new node.

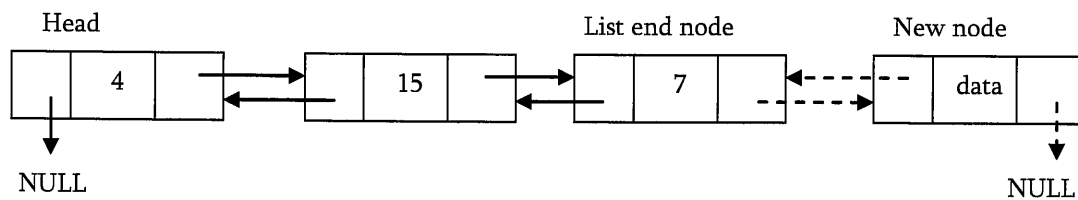

Inserting a Node in Doubly Linked List at the Middle

As discussed in singly linked lists, traverse the list till the position node and insert the new node.

- *New node* right pointer points to the next node of the *position node* where we want to insert the new node. Also, *new node* left pointer points to the *position node*.

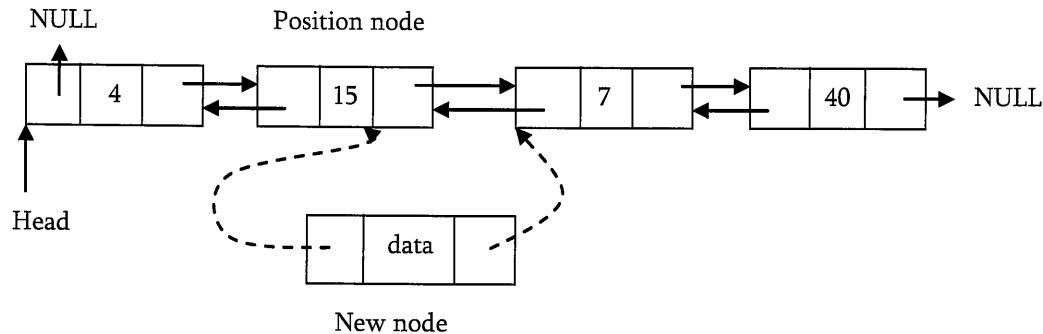

- Position node right pointer points to the new node and the *next node* of position nodes left pointer points to new node.

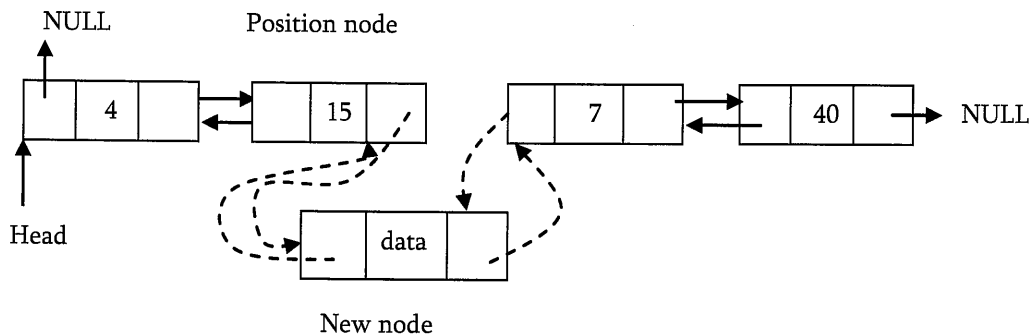

Now, let us write the code for all these three cases. We must update the first element pointer in the calling function, not just in the called function. For this reason we need to send double pointer. The following code inserts a node in the doubly linked list.

```
void DLLInsert(struct DLLNode **head, int data, int position) {
    int k = 1;
    struct DLLNode *temp, *newNode;
    newNode = (struct DLLNode *) malloc(sizeof ( struct DLLNode ));
    if(!newNode) {
        //Always check for memory errors
        printf ("Memory Error"); return;
    }
    newNode->data = data;
    if(position == 1) {
        //Inserting a node at the beginning
        newNode->next = *head;
        newNode->prev = NULL;
        *head->prev = newNode;
        *head = newNode;
        return;
    }
}
```

```

}
temp = *head;
while ( (k < position - 1) && temp->next!=NULL) {
    temp = temp->next;
    k++;
}
if( temp->next== NULL) {           //Insertion at the end
    newNode->next = temp->next;
    newNode->prev = temp;
    temp->next = newNode;
}
else {                             //Insertion in the middle
    newNode->next = temp->next;
    newNode->prev = temp;
    temp->next->prev = newNode;
    temp->next = newNode;
}
return;
}

```

Time Complexity: $O(n)$. In the worst we may need to insert the node at the end of the list. Space Complexity: $O(1)$, for creating one temporary variable.

Doubly Linked List Deletion

As similar to singly linked list deletion, here also we have three cases:

- Deleting the first node
- Deleting the last node
- Deleting an intermediate node

Deleting the First Node in Doubly Linked List

In this case, first node (current head node) is removed from the list. It can be done in two steps:

- Create a temporary node which will point to same node as that of head.

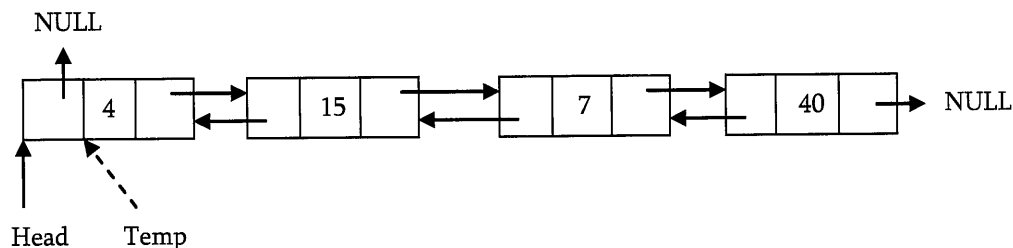

- Now, move the head nodes pointer to the next node and change the heads left pointer to NULL. Then, dispose the temporary node.

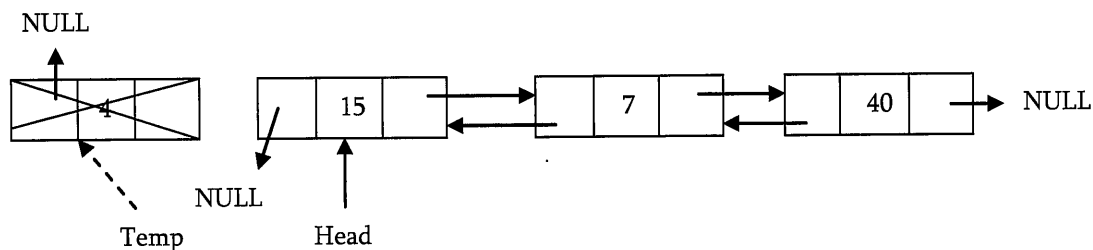

Deleting the Last Node in Doubly Linked List

This operation is a bit trickier, than removing the first node, because algorithm should find a node, which is previous to the tail first. It can be done in three steps:

- Traverse the list and while traversing maintain the previous node address also. By the time we reach the end of list, we will have two pointers one pointing to the NULL (tail) and other pointing to the node before tail node.

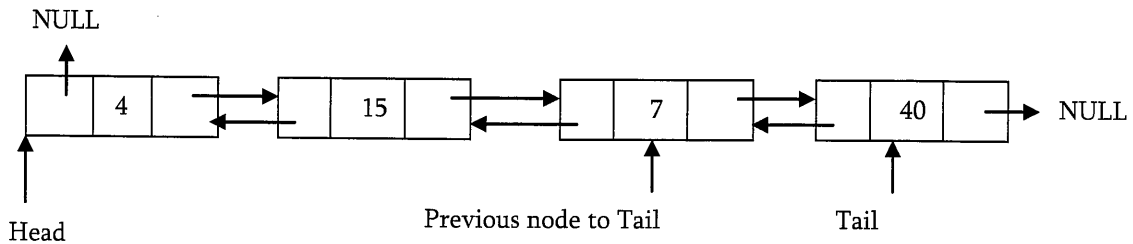

- Update tail nodes previous nodes next pointer with NULL.

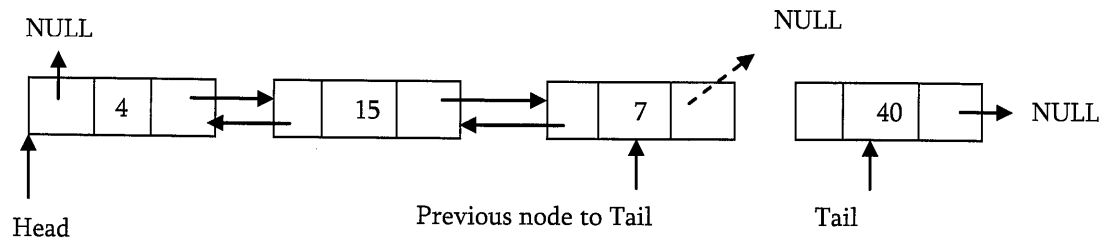

- Dispose the tail node.

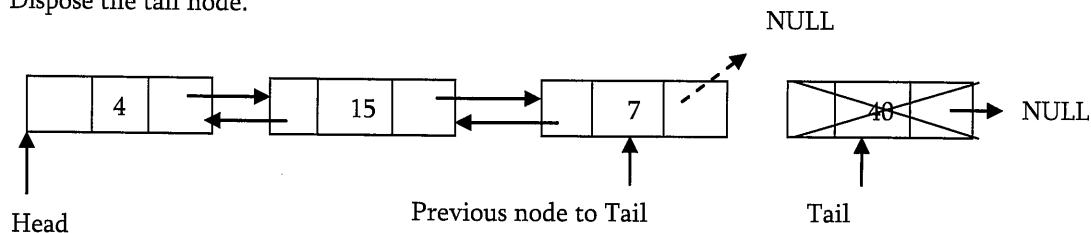

Deleting an Intermediate Node in Doubly Linked List

In this case, node to be removed is *always located between two nodes*. Head and tail links are not updated in this case. Such a removal can be done in two steps:

- As similar to previous case, maintain previous node also while traversing the list. Once we found the node to be deleted, change the previous nodes next pointer to the next node of the node to be deleted.

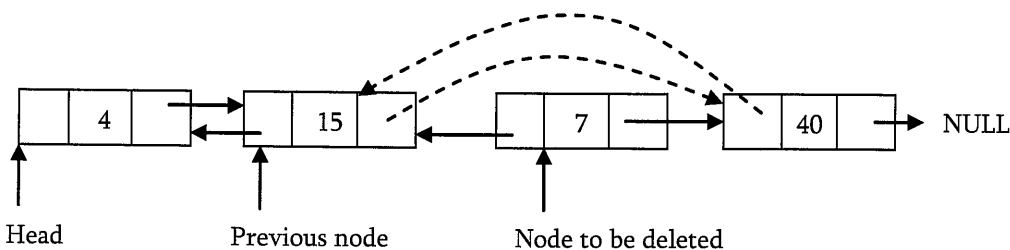

- Dispose the current node to be deleted.

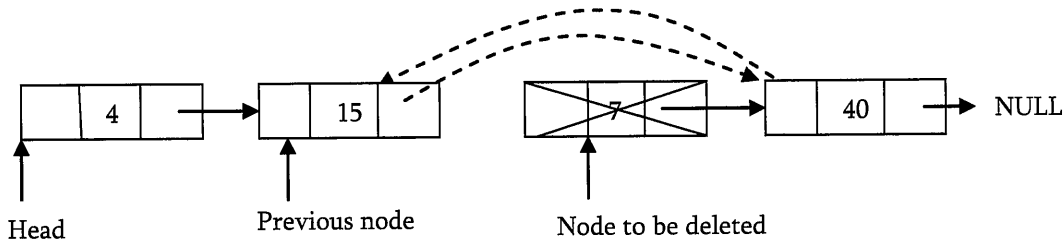

```

void DLLDelete(struct DLLNode **head, int position) {
    struct DLLNode *temp, *temp2, temp = *head;
    int k = 1;
    if(*head == NULL) {
        printf("List is empty"); return;
    }
    if(position == 1) {
        *head = *head->next;
        if(*head != NULL)
            *head->prev = NULL;
        free(temp);
        return;
    }
    while((k < position - 1) && temp->next!=NULL) {
        temp = temp->next;
        k++;
    }
    if( temp->next== NULL) { //Deletion from end
        temp2 = temp->prev;
        temp2->next = NULL;
        free(temp);
    }
    else {
        temp2 = temp->prev;
        temp2->next = temp->next;
        temp->next->prev = temp2;
        free (temp);
    }
    return;
}

```

Time Complexity: $O(n)$, for scanning the complete list of size n . Space Complexity: $O(1)$, for creating one temporary variable.

3.8 Circular Linked Lists

In singly linked lists and doubly linked lists the end of lists are indicated with NULL value. But circular linked lists do not have ends. While traversing the circular linked lists we should be careful otherwise we will be traversing the list infinitely. In circular linked lists each node has a successor. Note that unlike singly linked lists, there is no node with NULL pointer in a circularly linked list. In some situations, circular linked lists are useful.

For example, when several processes are using the same computer resource (CPU) for the same amount of time, and we have to assure that no process accesses the resource before all other processes did (round robin algorithm). Following is a type declaration for a circular linked list of integers:

```
typedef struct CLLNode {
```

```

    int data;
    struct ListNode *next;
};

```

In circular linked list we access the elements using the *head* node (similar to *head* node in singly linked list and doubly linked lists).

Counting Nodes in a Circular List

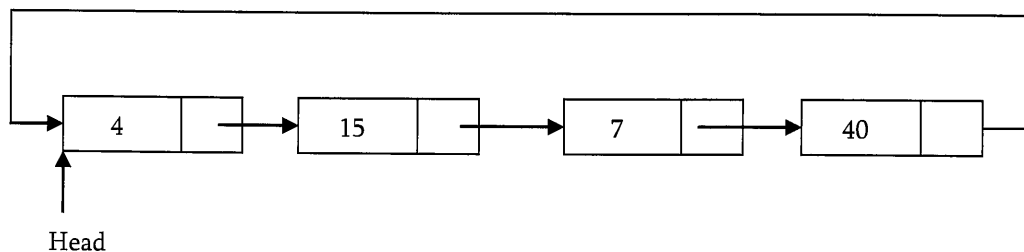

The circular list is accessible through the node marked *head*. To count the nodes, the list has to be traversed from node marked *head*, with the help of a dummy node *current* and stop the counting when *current* reaches the starting node *head*. If the list is empty, *head* will be NULL, and in that case set *count* = 0. Otherwise, set the current pointer to the first node, and keep on counting till the current pointer reaches the starting node.

```

int CircularListLength(struct CLLNode *head) {
    struct CLLNode *current = head;
    int count = 0;
    if(head == NULL) return 0;
    do {
        current = current->next;
        count++;
    } while (current != head);
    return count;
}

```

Time Complexity: $O(n)$, for scanning the complete list of size n . Space Complexity: $O(1)$, for creating one temporary variable.

Printing the contents of a circular list

We assume here that the list is being accessed by its *head* node. Since all the nodes are arranged in a circular fashion, the *tail* node of the list will be the node next to the *head* node. Let us assume we want to print the contents of the nodes starting with the *head* node. Print its contents, move to the next node and continue printing till we reach the *head* node again.

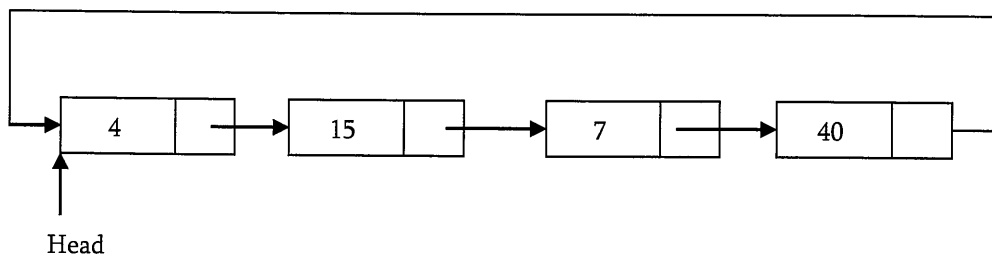

```

void PrintCircularListData(struct CLLNode *head) {
    struct CLLNode *current = head;
    if(head == NULL) return;
    do {
        printf ("%d", current->data);
        current = current->next;
    }
}

```

```

    } while (current != head);
}

```

Time Complexity: $O(n)$, for scanning the complete list of size n . Space Complexity: $O(1)$, for creating ne temporary variable.

Inserting a Node at the End of a Circular Linked List

Let us add a node containing *data*, at the end of a list (circular list) headed by *head*. The new node will be placed just after the tail node (which is the last node of the list), which means it will have to be inserted in between the tail node and the first node.

- Create a new node and initially keep its next pointer points to itself.

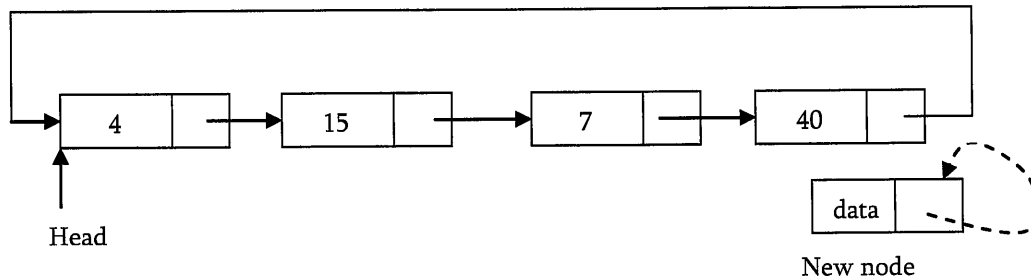

- Update the next pointer of new node with head node and also traverse the list until the tail. That means in circular list we should stop at a node whose next node is head.

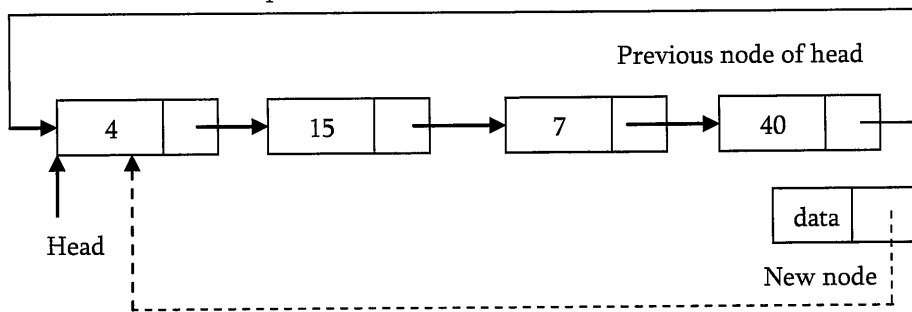

- Update the next pointer of previous node to point to new node and we get the list as shown below.

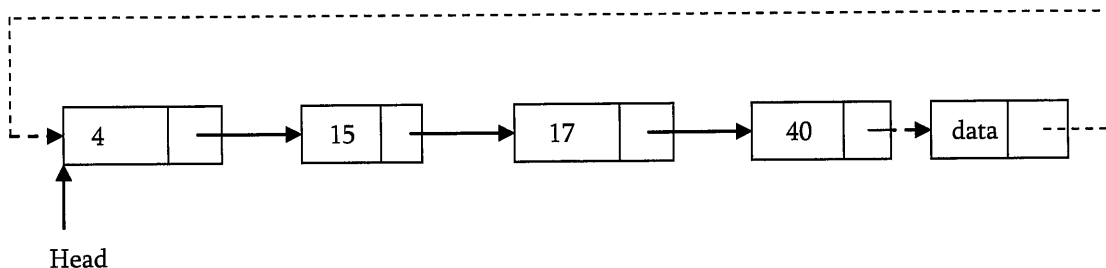

```

void InsertAtEndInCLL (struct CLLNode **head, int data) {
    struct CLLNode current = *head;
    struct CLLNode *newNode = (struct node*) (malloc(sizeof(struct CLLNode)));
    if(!newNode) {
        printf("Memory Error"); return;
    }
    newNode->data = data;
    while (current->next != *head)
        current = current->next;
    newNode->next = *head;
    if(*head == NULL)

```

```

        *head = newNode;
    else {
        newNode->next = *head;
        current->next = newNode;
    }
}

```

Time Complexity: $O(n)$, for scanning the complete list of size n . Space Complexity: $O(1)$, for creating one temporary variable.

Inserting a Node at Front of a Circular Linked List

The only difference between inserting a node at the beginning and at the ending is that, after inserting the new node we just need to update the pointer. Below are the steps for doing the same.

- Create a new node and initially keep its next pointer points to itself.

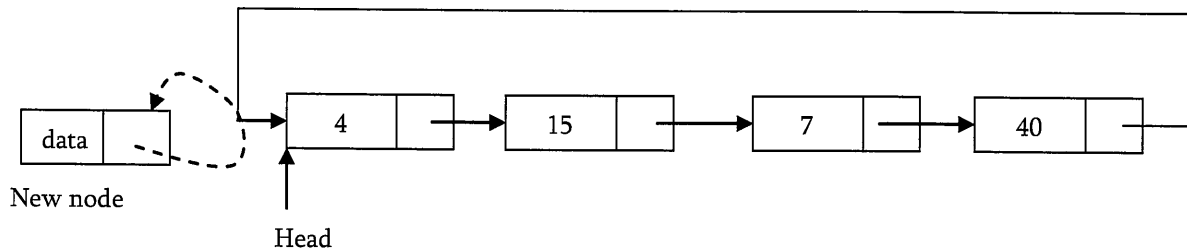

- Update the next pointer of new node with head node and also traverse the list until the tail. That means in circular list we should stop at the node which is previous node in the list.

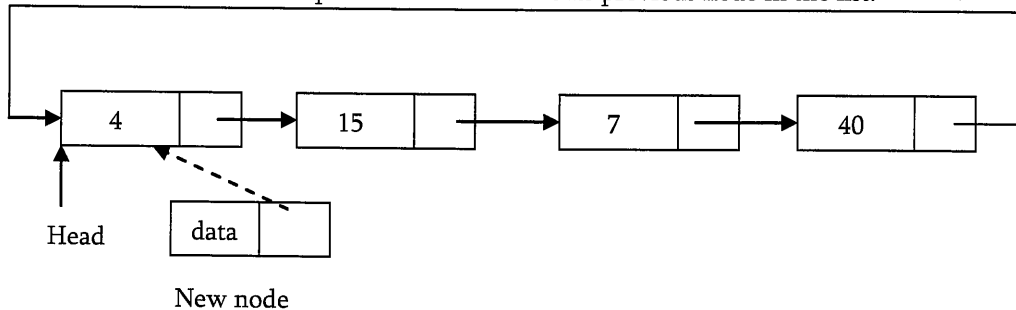

- Update the previous node of head in the list to point to new node.

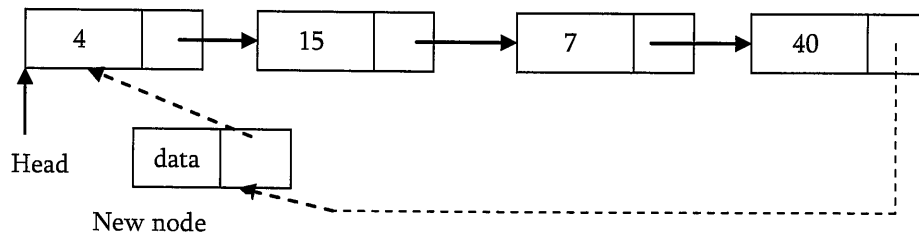

- Make new node as head.

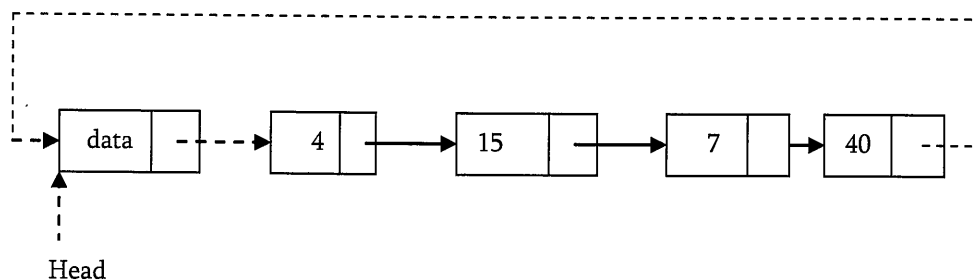

```
void InsertAtBeginInCLL (struct CLLNode **head, int data) {
```



```

struct CLLNode *current = *head;
struct CLLNode * newNode = (struct node*) (malloc(sizeof(struct CLLNode)));
if(!newNode) {
    printf("Memory Error"); return;
}
newNode->data = data;
while (current->next != *head)
    current = current->next;
newNode->next = *head;
if(*head ==NULL) *head = newNode;
else {
    newNode->next = *head;
    current->next = newNode;
    *head = newNode;
}
Return;
}

```

Time Complexity: $O(n)$, for scanning the complete list of size n . Space Complexity: $O(1)$, for creating only one temporary variable.

Deleting the Last Node in a Circular List

The list has to be traversed to reach the last but one node. This has to be named as the tail node, and its next field has to point to the first node. Consider the following list. To delete the last node 40, the list has to be traversed till you reach 7. The next field of 7 has to be changed to point to 60, and this node must be renamed *pTail*.

- Traverse the list and find the tail node and its previous node.

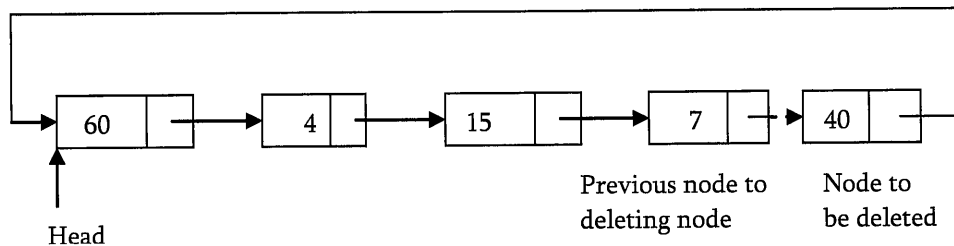

- Update the tail nodes previous node next pointer to point to head.

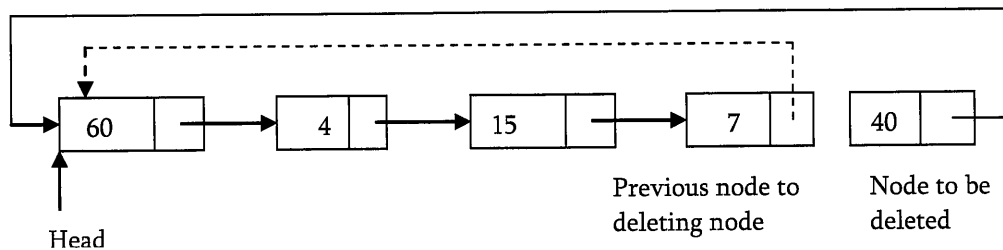

- Dispose the tail node.

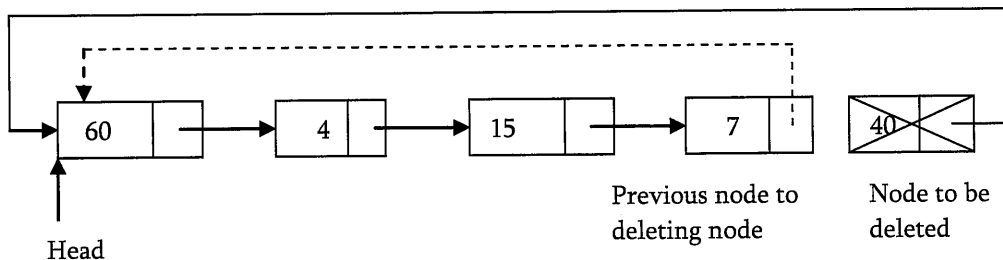

```

void DeleteLastNodeFromCLL (struct CLLNode **head) {
    struct CLLNode *temp = *head;
    struct CLLNode *current = *head;
    if(*head == NULL) {
        printf( "List Empty");
        return;
    }
    while (current->next != *head) {
        temp = current;
        current = current->next;
    }
    free(current);
    return;
}

```

Time Complexity: $O(n)$, for scanning the complete list of size n . Space Complexity: $O(1)$, for creating one temporary variable.

Deleting the First Node in a Circular List

The first node can be deleted by simply replacing the next field of tail node with the next field of the first node.

- Find the tail node of the linked list by traversing the list. Tail node is the previous node to the head node which we want to delete.

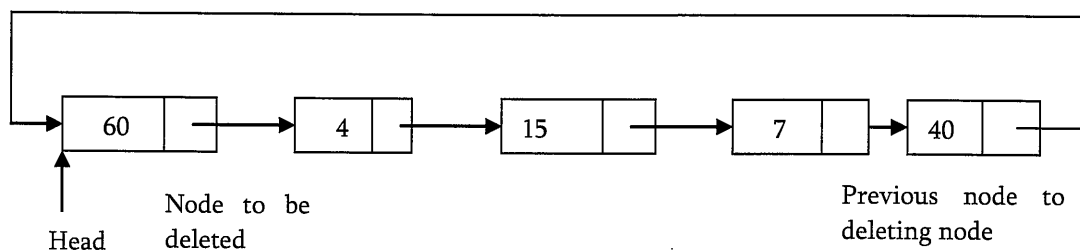

- Create a temporary which will point to head. Also, update the tail nodes next pointer to point to next node of head (as shown below).

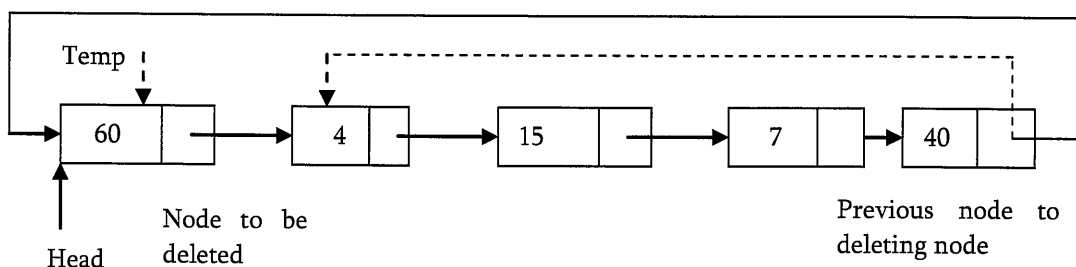

- Now, move the head pointer to next node. Create a temporary which will point to head. Also, update the tail nodes next pointer to point to next node of head (as shown below).

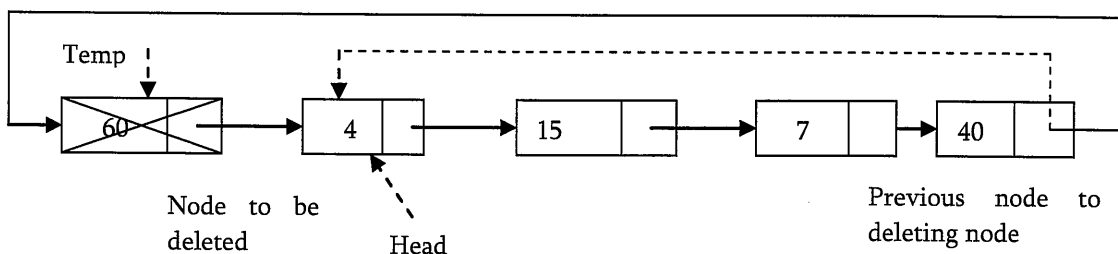

```

void DeleteFrontNodeFromCLL (struct CLLNode **head) {
    struct CLLNode *temp = *head;
    struct CLLNode *current = *head;
    if(*head == NULL) {
        printf("List Empty"); return;
    }
    while (current->next != *head)
        current = current->next;
    current->next = *head->next;
    *head = *head->next;
    free(temp);
    return;
}

```

Time Complexity: $O(n)$, for scanning the complete list of size n . Space Complexity: $O(1)$, for creating one temporary variable.

Applications of Circular List

Circular linked lists are used in managing the computing resources of a computer. We can use circular lists for implementing stacks and queues.

3.9 A Memory-Efficient Doubly Linked List

In conventional implementation, we need to keep a forward pointer to the next item on the list and a backward pointer to the previous item. That means, elements in doubly linked list implementations consists of data, a pointer to the next node and a pointer to the previous node in the list as shown below.

Conventional Node Definition

```

typedef struct ListNode {
    int data;
    struct ListNode * prev;
    struct ListNode * next;
};

```

Recently a journal (Sinha) presented an alternative implementation of the doubly linked list ADT, with insertion, traversal and deletion operations. This implementation is based on pointer difference. Each node uses only one pointer field to traverse the list back and forth.

New Node Definition

```

typedef struct ListNode {
    int data;
    struct ListNode * ptrdiff;
};

```

The *ptrdiff* pointer field contains the difference between the pointer to the next node and the pointer to the previous node. Pointer difference is calculated by using exclusive-or (\oplus) operation.

$$ptrdiff = \text{pointer to previous node} \oplus \text{pointer to next node.}$$

The *ptrdiff* of the start node (head node) is the \oplus of NULL and *next* node (next node to head). Similarly, the *ptrdiff* of end node is the \oplus of *previous* node (previous to end node) and NULL. As an example, consider the following linked list.

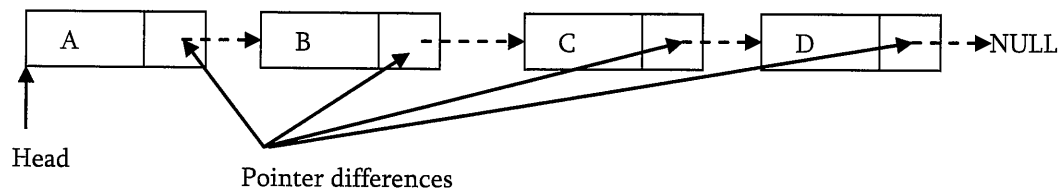

In the above example,

- The next pointer of A is: $\text{NULL} \oplus B$
- The next pointer of B is: $A \oplus C$
- The next pointer of C is: $B \oplus D$
- The next pointer of D is: $C \oplus \text{NULL}$

Why does it work?

To have answer for this question let us consider the properties of \oplus :

$$X \oplus X = 0$$

$$X \oplus 0 = X$$

$$X \oplus Y = Y \oplus X \text{ (symmetric)}$$

$$(X \oplus Y) \oplus Z = X \oplus (Y \oplus Z) \text{ (transitive)}$$

For the above example, let us assume that we are at C node and want to move to B. We know that Cs *ptrdiff* is defined as $B \oplus D$. If we want to move to B, performing \oplus on Cs *ptrdiff* with D would give B. This is due to fact that,

$$(B \oplus D) \oplus D = B \text{ (since, } D \oplus D = 0)$$

Similarly, if we want to move to D, then we have to applying \oplus to Cs *ptrdiff* with B would give D.

$$(B \oplus D) \oplus B = D \text{ (since, } B \oplus B = 0)$$

From the above discussion we can see that just by using single pointer, we are able to move back and forth. A memory-efficient implementation of a doubly linked list is possible to have without compromising much timing efficiency.

3.10 Problems on Linked Lists

Problem-1 Implement Stack using Linked List

Solution: Refer *Stacks* chapter.

Problem-2 Find n^{th} node from the end of a Linked List.

Solution: Brute-Force Method: Start with the first node and count how many nodes are there after that node. If the number of nodes are $< n - 1$ then return saying “fewer number of nodes in the list”. If the number of nodes are $> n - 1$ then go to next node. Continue this until the numbers of nodes after current node are $n - 1$.

Time Complexity: $O(n^2)$, for scanning the remaining list (from current node) for each node. Space Complexity: $O(1)$.

Problem-3 Can we improve the complexity of Problem-2?

Solution: Yes, using hash table. As an example consider the following list.

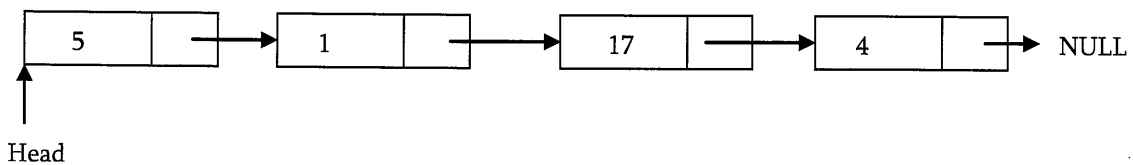

In this approach, create a hash table whose entries are $\langle \text{position of node, node address} \rangle$. That means, key is the position of the node in the list and value is the address of that node.

Position in List	Address of Node
1	Address of 5 node
2	Address of 1 node
3	Address of 17 node
4	Address of 4 node

By the time we traverse the complete list (for creating hash table), we can find the list length. Let us say, the list length is M . To find n^{th} from end of linked list, we can convert this to $M - n + 1^{th}$ from the beginning. Since we already know the length of the list, it's just a matter of returning $M - n + 1^{th}$ key value from the hash table.

Time Complexity: Time for creating the hash table. Therefore, $T(m) = O(m)$. Space Complexity: $O(m)$. Since, we need to create a hash table of size m .

Problem-4 Can we use Problem-3 approach for solving Problem-2 without creating the hash table?

Solution: Yes. If we observe the Problem-3 solution, what actually we are doing is finding the size of the linked list. That means, we are using hash table to find the size of the linked list. We can find the length of the linked list just by starting at the head node and traversing the list. So, we can find the length of the list without creating the hash table. After finding the length, compute $M - n + 1$ and with one more scan we can get the $M - n + 1^{th}$ node from the beginning. This solution needs two scans: one for finding the length of list and other for finding $M - n + 1^{th}$ node from the beginning.

Time Complexity: Time for finding the length + Time for finding the $M - n + 1^{th}$ node from the beginning. Therefore, $T(n) = O(n) + O(n) \approx O(n)$. Space Complexity: $O(1)$. Since, no need of creating the hash table.

Problem-5 Can we solve Problem-2 in one scan?

Solution: Yes. Efficient Approach: Use two pointers $pNthNode$ and $pTemp$. Initially, both points to head node of the list. $pNthNode$ starts moving only after $pTemp$ made n moves. From there both moves forward until $pTemp$ reaches end of the list. As a result $pNthNode$ points to n^{th} node from end of the linked list.

Note: at any point of time both moves one node at time.

```

struct ListNode *NthNodeFromEnd(struct ListNode *head , int NthNode) {
    struct ListNode *pTemp = NULL, *pNthNode = NULL;
    int count = 0;
    for (pTemp = head; pTemp!= NULL;) {
        count++;
        if(NthNode - count == 0 )
            pNthNode = head;
        else if(NthNode - count > 0)
            pNthNode = pNthNode->pNext;
        pTemp = pTemp->pNext;
    }
    if(pNthNode) return pNthNode;
    return NULL;
}

```

Time Complexity: $O(n)$. Space Complexity: $O(1)$.

Problem-6 Check whether the given linked list is either NULL-terminated or ends in a cycle (cyclic)

Solution: Brute-Force Approach. As an example consider the following linked list which has a loop in it. The difference between this list and regular list is that, in this list there are two nodes whose next pointers are same. In regular singly linked lists (without loop) each nodes next pointer is unique. That means, the repetition of next pointers indicates the existence of loop.

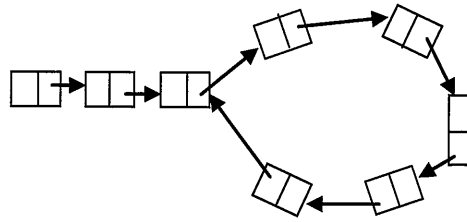

One simple and brute force way of solving this is, start with the first node and see whether there is any node whose next pointer is current nodes address. If there is a node with same address then that indicates that some other node is pointing to the current node and we can say loops exists. Continue this process for all the nodes of the linked list.

Does this method works? As per the algorithm we are checking for the next pointer addresses, but how do we find the end of the linked list (otherwise we will end up in infinite loop)?

Note: If we start with a node in loop, this method may work depending on the size of the loop.

Problem-7 Can we use hashing technique for solving Problem-6?

Solution: Yes. Using Hash Tables we can solve this problem.

Algorithm:

- Traverse the linked list nodes one by one.
- Check if the nodes address is there in the hash table or not.
- If it is already there in the hash table then that indicates that we are visiting the node which was already visited. This is possible only if the given linked list has a loop in it.
- If the address of the node is not there in the hash table then insert that nodes address into the hash table.
- Continue this process until we reach end of the linked list *or* we find loop.

Time Complexity: $O(n)$ for scanning the linked list. Note that we are doing only scan of the input. Space Complexity: $O(n)$ for hash table.

Problem-8 Can we solve the Problem-6 using sorting technique?

Solution: No. Consider the following algorithm which is based on sorting. And then, we see why this algorithm fails.

Algorithm:

- Traverse the linked list nodes one by one and take all the next pointer values into some array.
- Sort the array which is having next node pointers.
- If there is a loop in the linked list, definitely two nodes next pointers will pointing to the same node.
- After sorting if there is a loop in the list, the nodes whose next pointers are same will come adjacent in the sorted list.
- If there is any such pair exists in the sorted list then we say the linked list has loop in it.

Time Complexity: $O(n \log n)$ for sorting the next pointers array. Space Complexity: $O(n)$ for the next pointers array.

Problem with above algorithm? The above algorithm works only if we can find the length of the list. But if the list is having loop then we may end up in infinite loop. Due to this reason the algorithm fails.

Problem-9 Can we solve the Problem-6 in $O(n)$?

Solution: Yes. **Efficient Approach (Memory less Approach):** This problem was solved by *Floyd*. The solution is named as Floyd cycle finding algorithm. It uses 2 pointers moving at different speeds to walk the linked list. Once they enter the loop they are expected to meet, which denotes that there is a loop. This works because the only way a faster moving pointer would point to the same location as a slower moving pointer is, if somehow the entire list or a part of it is circular.

Think of a tortoise and a hare running on a track. The faster running hare will catch up with the tortoise if they are running in a loop. As an example, consider the following example and trace out the Floyd algorithm. From the below diagrams we can see that after the final step they are meeting at some point in the loop which may not be the starting of the loop.

Note: *slowPtr* (*tortoise*) moves one pointer at a time and *fastPtr* (*hare*) moves two pointers at a time.

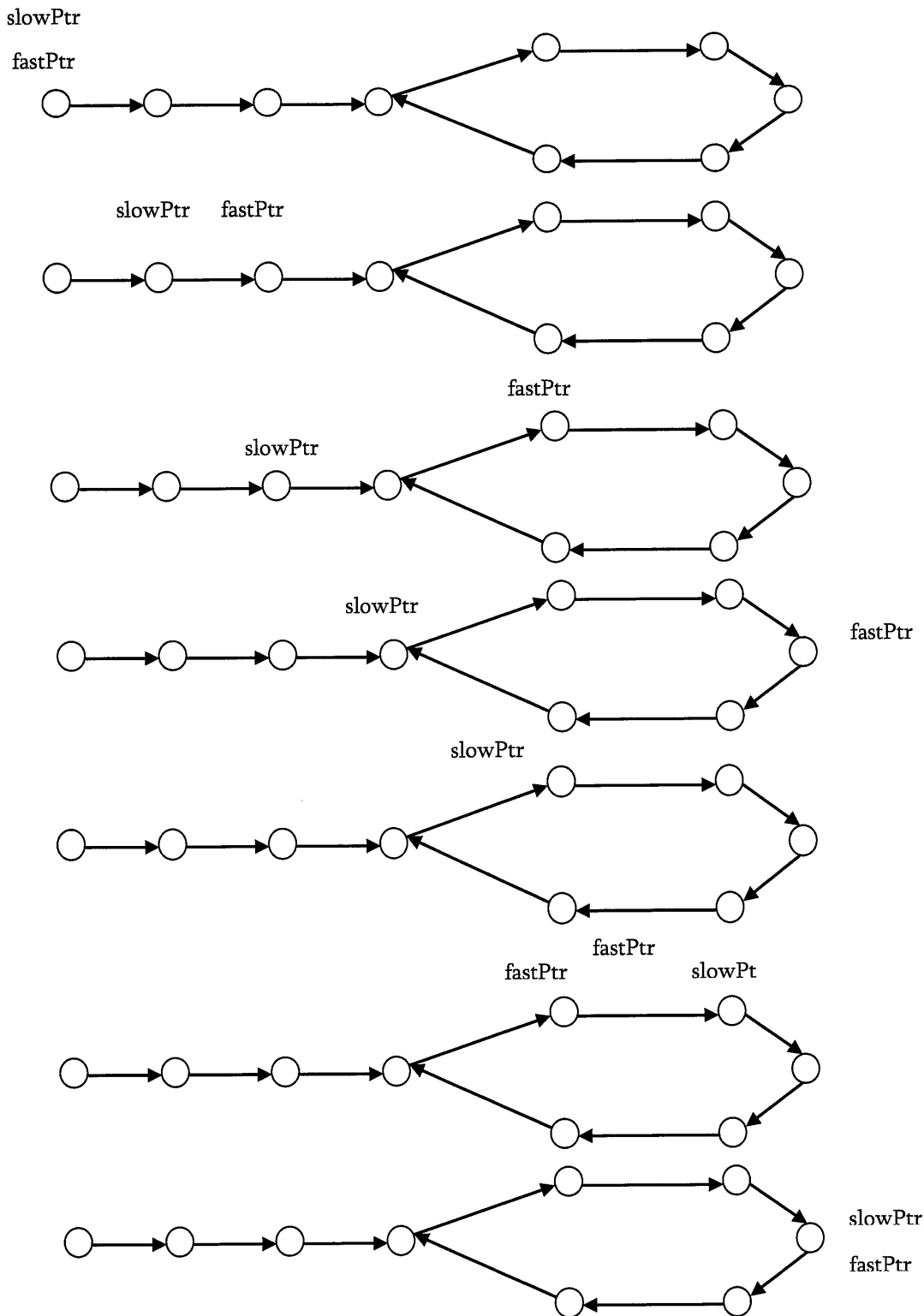

```
int IsLinkedListContainsLoop(struct ListNode * head) {
    struct ListNode *slowPtr = head, *fastPtr = head;
    while(slowPtr && fastPtr) {
        fastPtr = fastPtr->next;
        if(fastPtr == slowPtr)
```

```

        return 1;
    if(fastPtr == NULL)
        return 0;
    fastPtr = fastPtr->next;
    if(fastPtr == slowPtr)
        return 1;
    slowPtr = slowPtr->next;
}
return 0;
}

```

Time Complexity: $O(n)$. Space Complexity: $O(1)$.

Problem-10 We are given a pointer to the first element of a linked list L . There are two possibilities for L , it either ends (snake) or its last element points back to one of the earlier elements in the list (snail). Give an algorithm that tests whether a given list L is a snake or a snail.

Solution: It is same as Problem-6.

Problem-11 Check whether the given linked list is either NULL-terminated or not. If there is a cycle find the start node of the loop.

Solution: The solution is an extension to the previous solution (Problem-9). After finding the loop in the linked list, we initialize the *slowPtr* to head of the linked list. From that point onwards both *slowPtr* and *fastPtr* moves only one node at a time. The point at which they meet is the start of the loop. Generally we use this method for removing the loops.

```

int FindBeginofLoop(struct ListNode * head) {
    struct ListNode *slowPtr = head, *fastPtr = head;
    int loopExists = 0;
    while(slowPtr && fastPtr) {
        fastPtr = fastPtr->next;
        if(fastPtr == slowPtr) {
            loopExists = 1;
            break;
        }
        if(fastPtr == NULL)
            loopExists = 0;
        fastPtr = fastPtr->next;
        if(fastPtr == slowPtr) {
            loopExists = 1;
            break;
        }
        slowPtr = slowPtr->next;
    }
    if(loopExists) {
        slowPtr = head;
        while(slowPtr != fastPtr) {
            fastPtr = fastPtr->next;
            slowPtr = slowPtr->next;
        }
        return slowPtr;
    }
    return NULL;
}

```



```
}
Time Complexity:  $O(n)$ . Space Complexity:  $O(1)$ .
```

Problem-12 From the previous discussion and problems we understand that tortoise and hares meeting concludes the existence of loop, but how does moving tortoise to beginning of linked list while keeping the hare at meeting place, followed by moving both one step at a time make them meet at starting point of cycle?

Solution: This problem is the heart of number theory. In Floyd cycle finding algorithm, notice that the tortoise and the hare will meet when they are $n \times L$, where L is the loop length. Furthermore, the tortoise is at the midpoint between the hare and the beginning of the sequence, because of the way they move. Therefore the tortoise is $n \times L$ away from the beginning of the sequence as well.

If we move both one step at a time, from the tortoise position and from the start of the sequence, we know that they will meet as soon as both are in the loop, since they are $n \times L$, a multiple of the loop length, apart. One of them is already in the loop, so we just move the other one in single step until it enters the loop, keeping the other $n \times L$ away from it at all times.

Problem-13 In Floyd cycle finding algorithm, does it work if we use the step 2 and 3 instead of 1 and 2?

Solution: Yes, but the complexity might be more. Trace out some example.

Problem-14 Check whether the given linked list is either NULL-terminated or not. If there is a cycle find the length of the loop.

Solution: This solution is also an extension to the basic cycle detection problem. After finding the loop in the linked list, initialize the *slowPtr* to *fastPtr*. *slowPtr* keeps on moving until it again comes back to *fastPtr*. While moving *slowPtr*, use a counter variable which increments at the rate of 1.

```
int FindLoopLength(struct ListNode * head) {
    struct ListNode *slowPtr = head, *fastPtr = head;
    int loopExists = 0, counter = 0;
    while(slowPtr && fastPtr) {
        fastPtr = fastPtr->next;
        if(fastPtr == slowPtr)
            loopExists = 1;
        if(fastPtr == NULL)
            loopExists = 0;
        fastPtr = fastPtr->next;
        if(fastPtr == slowPtr) loopExists = 1;
        slowPtr = slowPtr->next;
    }
    if(loopExists) {
        fastPtr = fastPtr->next;
        while(slowPtr != fastPtr) {
            fastPtr = fastPtr->next;
            counter++;
        }
        return counter;
    }
    return 0; //If no loops exists
}
```

Time Complexity: $O(n)$. Space Complexity: $O(1)$.

Problem-15 Insert a node in a sorted linked list

Solution: Traverse the list and find a position for the element and insert it.

```

struct ListNode *InsertInSortedList(struct ListNode * head, struct ListNode * newNode) {
    struct ListNode *current = head, temp;
    if(!head) return newNode;
    // traverse the list until you find item bigger the new node value
    while (current != NULL && current->data < newNode->data){
        temp = current;
        current = current->next;
    }
    //insert the new node before the big item
    newNode->next = current;
    temp->next = newNode;
    return head;
}

```

Time Complexity: $O(n)$. Space Complexity: $O(1)$.

Problem-16 Reverse a singly linked list

Solution: // iterative version

```

struct ListNode *ReverseList(struct ListNode *head) {
    struct ListNode *temp = NULL, *nextNode = NULL;
    while (head) {
        nextNode = head->next;
        head->next = temp;
        temp = head;
        head = nextNode;
    }
    return temp;
}

```

Time Complexity: $O(n)$. Space Complexity: $O(1)$.

Problem-17 Suppose there are two singly linked lists both of which intersect at some point and become a single linked list. The head or start pointers of both the lists are known, but the intersecting node is not known. Also, the number of nodes in each of the list before they intersect are unknown and both list may have it different. *List1* may have n nodes before it reaches intersection point and *List2* might have m nodes before it reaches intersection point where m and n may be $m = n, m < n$ or $m > n$. Give an algorithm for finding the merging point.

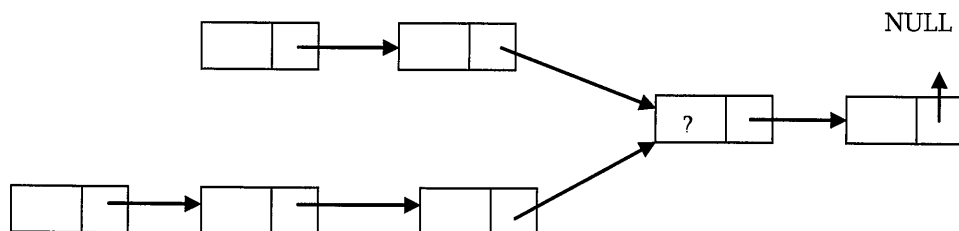

Solution: Brute-Force Approach: One easy solution is to compare every node pointer in the first list with every other node pointer in the second list by which the matching node pointers will lead us to the intersecting node. But, the time complexity in this case will $O(mn)$ which will be high.

Time Complexity: $O(mn)$. Space Complexity: $O(1)$.

Problem-18 Can we solve Problem-17 using sorting technique?

Solution: No. Consider the following algorithm which is based on sorting and see why this algorithm fails.

Algorithm

- Take first list node pointers and keep in some array and sort them.

- Take second list node pointers and keep in some array and sort them.
- After sorting, use two indexes: one for first sorted array and other for second sorted array.
- Start comparing values at the indexes and increment the index whichever is having lower value (increment only if the values are not equal).
- At any point, if we were able to find two indexes whose values are same then that indicates that those two nodes are pointing to the same node and we return that node.

Time Complexity: Time for sorting lists + Time for scanning (for comparing) = $O(m \log m) + O(n \log n) + O(m + n)$. We need to consider the one which gives the maximum value. Space Complexity: $O(1)$.

Problem with the above algorithm? Yes. In the algorithm, we are storing all the node pointers of both the lists and sorting. But we are forgetting the fact that, there can be many repeated elements. This is because after the merging point all node pointers are same for both the lists. The algorithm works fine only in one case and it is when both lists have ending node at their merge point.

Problem-19 Can we solve Problem-17 using hash tables?

Solution: Yes.

Algorithm:

- Select a list which is having less number of nodes (If we do not know the lengths beforehand then select one list randomly).
- Now, traverse the other list and for each node pointer of this list check whether the same node pointer exists in the hash table or not.
- If there a merge point for the give lists then we will definitely encounter the node pointer in the hash table.

Time Complexity: Time for creating the hash table + Time for scanning the second list = $O(m) + O(n)$ (or $O(n) + O(m)$, depends on which list we select for creating the hash table). But in both cases the time complexity is same. Space Complexity: $O(n)$ or $O(m)$.

Problem-20 Can we use stacks for solving the Problem-17?

Solution: Yes.

Algorithm:

- Create two stacks: one for the first list and one for the second list.
- Traverse the first list and push all the node address on to the first stack.
- Traverse the second list and push all the node address on to the second stack.
- Now both stacks contain the node address of the corresponding lists.
- Now, compare the top node address of both stacks.
- If they are same, then pop the top elements from both the stacks and keep in some temporary variable (since both node addresses are node, it is enough if we use one temporary variable).
- Continue this process until top node addresses of the stacks are not same.
- This point is the one where the lists merge into single list.
- Return the value of the temporary variable.

Time Complexity: $O(m + n)$, for scanning both the lists. Space Complexity: $O(m + n)$, for creating two stacks for both the lists.

Problem-21 Is there any other way of solving the Problem-17?

Solution: Yes. Using “finding the first repeating number” approach in an array (for algorithm refer *Searching* chapter).

Algorithm:

- Create an array A and keep all the next pointers of both the lists in the array.
- In the array find the first repeating element in the array [Refer *Searching* chapter for algorithm].
- The first repeating number indicates the merging point of the both lists.

Time Complexity: $O(m + n)$. Space Complexity: $O(m + n)$.

Problem-22 Can we still think for finding alternative solution for the Problem-17?

Solution: Yes. By combining sorting and search techniques we can reduce the complexity.

Algorithm:

- Create an array A and keep all the next pointers of the first list in the array.
- Sort these array elements.
- Then, for each of the second list element, search in the sorted array (let us assume that we are using binary search which gives $O(\log n)$).
- Since we are scanning the second list one by one, the first repeating element which appears in the array is nothing but the merging point.

Time Complexity: Time for sorting + Time for searching = $O(\text{Max}(m \log m, n \log n))$. Space Complexity: $O(\text{Max}(m, n))$.

Problem-23 Can we improve the complexity for the Problem-17?

Solution: Yes.

Efficient Approach:

- Find lengths (L1 and L2) of both list -- $O(n) + O(m) = O(\text{max}(m, n))$.
- Take the difference d of the lengths -- $O(1)$.
- Make d steps in longer list -- $O(d)$.
- Step in both lists in parallel until links to next node match -- $O(\text{min}(m, n))$.
- Total time complexity = $O(\text{max}(m, n))$.
- Space Complexity = $O(1)$.

```

struct ListNode* FindIntersectingNode(struct ListNode* list1, struct ListNode* list2) {
    int L1=0, L2=0, diff=0;
    struct ListNode *head1 = list1, *head2 = list2;
    while(head1!= NULL) {
        L1++;
        head1 = head1->next;
    }
    while(head2!= NULL) {
        L2++;
        head2 = head2->next;
    }
    diff = L1 - L2;
    if(L1 < L2) {
        head1 = list2;
        head2 = list1;
        diff = L2 - L1;
    }
    for(int i = 0; i < diff; i++)
        head1 = head1->next;
    while(head1 != NULL && head2 != NULL) {
        if(head1 == head2)
            return head1->data;
        head1= head1->next;
        head2= head2->next;
    }
    return NULL;
}

```

}

Problem-24 How will you find the middle of the linked list?

Solution: Brute-Force Approach: For each of the node count how many nodes are there in the list and see whether it is the middle.

Time Complexity: $O(n^2)$. Space Complexity: $O(1)$.

Problem-25 Can we improve the complexity of Problem-24?

Solution: Yes.

Algorithm:

- Traverse the list and find the length of the list.
- After finding the length, again scan the list and locate $n/2$ node from the beginning.

Time Complexity: Time for finding the length of the list + Time for locating middle node = $O(n) + O(n) \approx O(n)$.

Space Complexity: $O(1)$.

Problem-26 Can we use hash table for solving Problem-24?

Solution: Yes. The reasoning is same as that of Problem-3.

Time Complexity: Time for creating the hash table. Therefore, $T(n) = O(n)$. Space Complexity: $O(n)$. Since, we need to create a hash table of size n .

Problem-27 Can we solve Problem-24 just in one scan?

Solution: Efficient Approach: Use two pointers. Move one pointer at twice the speed of the second. When the first pointer reaches end of the list, the second pointer will be pointing to the middle node.

Note: If the list has even number of nodes, the middle node will be of $\lfloor n/2 \rfloor$.

```
struct ListNode * FindMiddle(struct ListNode *head) {
    struct ListNode *ptr1x, *ptr2x;
    ptr1x = ptr2x = head;
    int i=0;
    // keep looping until we reach the tail (next will be NULL for the last node)
    while(ptr1x->next != NULL) {
        if(i == 0) {
            ptr1x = ptr1x->next; //increment only the 1st pointer
            i=1;
        }
        else if( i == 1) {
            ptr1x = ptr1x->next; //increment both pointers
            ptr2x = ptr2x->next;
            i = 0;
        }
    }
    return ptr2x; //now return the ptr2 which points to the middle node
}
```

Time Complexity: $O(n)$. Space Complexity: $O(1)$.

Problem-28 How will you display a linked list from the end?

Solution: Traverse recursively till end of the linked list. While coming back, start printing the elements.

//This Function will print the linked list from end
void PrintListFromEnd(struct ListNode *head) {

```

        if(!head)
            return;
        PrintListFromEnd(head->next);
        printf("%d ",head->data);
    }

```

Time Complexity: $O(n)$. Space Complexity: $O(n)$ → for Stack.

Problem-29 Check whether the given Linked List length is even or odd?

Solution: Use $2x$ pointer. Take a pointer which moves at $2x$ [two nodes at a time]. At the end, if the length is even then pointer will be NULL otherwise it will point to last node.

```

int IsLinkedListLengthEven(struct ListNode * listHead) {
    while(listHead && listHead->next)
        listHead = listHead->next->next;
    if(!listHead)
        return 0;
    return 1;
}

```

Time Complexity: $O(\lfloor n/2 \rfloor) \approx O(n)$. Space Complexity: $O(1)$.

Problem-30 If the head of a linked list is pointing to k th element, then how will you get the elements before k th element?

Solution: Use Memory Efficient Linked Lists [XOR Linked Lists].

Problem-31 Given two sorted Linked Lists, we need to merge them into the third list in sorted order.

Solution:

```

struct ListNode *MergeList(struct ListNode *a, struct ListNode *b) {
    struct ListNode *result = NULL;
    if(a == NULL) return b;
    if(b == NULL) return a;
    if(a->data <= b->data) {
        result = a;
        result->next = MergeList(a->next, b);
    }
    else {
        result = b;
        result->next = MergeList(b->next, a);
    }
    return result;
}

```

Time Complexity – $O(n + m)$, where n and m are lengths of two lists.

Problem-32 Reverse the linked list in pairs. If you have a linked list that holds $1 \rightarrow 2 \rightarrow 3 \rightarrow 4 \rightarrow X$, then after the function has been called the linked list would hold $2 \rightarrow 1 \rightarrow 4 \rightarrow 3 \rightarrow X$.

Solution: //Recursive Version

```

void ReversePairRecursive(struct ListNode *head) {
    struct ListNode *temp;
    if(head == NULL || head->next == NULL)
        return; //base case for empty or 1 element list
    else { //Reverse first pair
        temp = head->next;

```

```

        head->next = temp->next;
        temp->next = head;
        //Call the method recursively for the rest of the list
        ReversePairRecursive(head->next);
    }
}
/*Iterative version*/
void ReversePairIterative(struct ListNode *head) {
    struct ListNode *temp, *temp2, *current = head;
    while(current != NULL && current->next != NULL) {
        //Swap the pair
        temp = current->next;
        temp2 = temp->next;
        temp->next = current;
        current->next = temp2;
        //Advance the current pointer
        if(current)
            current = current->next;
    }
}

```

Time Complexity – $O(n)$. Space Complexity - $O(1)$.

Problem-33 Given a binary tree convert it to doubly linked list.

Solution: Refer *Trees* chapter.

Problem-34 How do we sort the Linked Lists?

Solution: Refer *Sorting* chapter.

Problem-35 If we want to concatenate two linked lists which of the following gives $O(1)$ complexity?

- 1) Singly linked lists 2) Doubly linked lists 3) Circular doubly linked lists

Solution: Circular Doubly Linked Lists. This is because for singly and doubly linked lists, we need to traverse the first list till the end and append the second list. But in case of circular doubly linked lists we don't have to traverse the lists.

Problem-36 Split a Circular Linked List into two equal parts. If the number of nodes in the list are odd then make first list one node extra than second list.

Solution:

Algorithm

- Store the mid and last pointers of the circular linked list using Floyd cycle finding algorithm.
- Make the second half circular.
- Make the first half circular.
- Set head pointers of the two linked lists.

As an example, consider the following circular list.

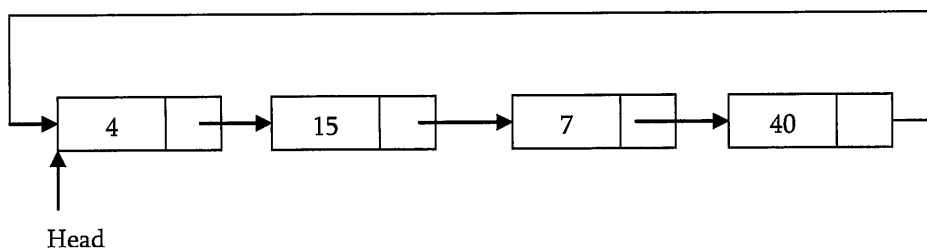

After the split, the above list will look like:

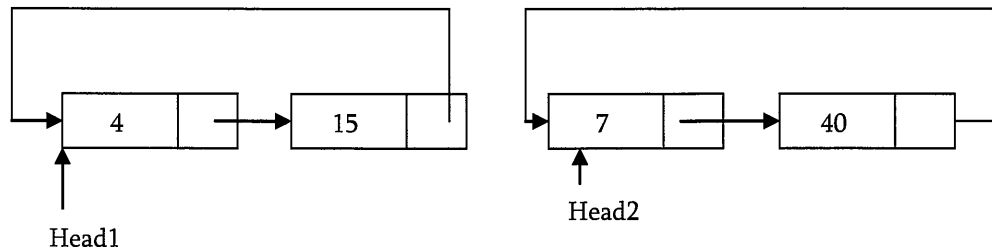

```

/* structure for a node */
struct ListNode {
    int data;
    struct ListNode *next;
};

void SplitList(struct ListNode *head, struct ListNode **head1, struct ListNode **head2) {
    struct ListNode *slowPtr = head;
    struct ListNode *fastPtr = head;
    if(head == NULL) return;
    /* If there are odd nodes in the circular list then fastPtr->next becomes
       head and for even nodes fastPtr->next->next becomes head */
    while(fastPtr->next != head && fastPtr->next->next != head) {
        fastPtr = fastPtr->next->next;
        slowPtr = slowPtr->next;
    }
    /* If there are even elements in list then move fastPtr */
    if(fastPtr->next->next == head)
        fastPtr = fastPtr->next;
    /* Set the head pointer of first half */
    *head1 = head;
    /* Set the head pointer of second half */
    if(head->next != head)
        *head2 = slowPtr->next;
    /* Make second half circular */
    fastPtr->next = slowPtr->next;
    /* Make first half circular */
    slowPtr->next = head;
}

```

Time Complexity: $O(n)$. Space Complexity: $O(1)$.

Problem-37 How will you check if the linked list is palindrome or not?

Solution:

Algorithm

1. Get the middle of the linked list.
2. Reverse the second half of the linked list.
3. Compare the first half and second half.
4. Construct the original linked list by reversing the second half again and attaching it back to the first half.

Time Complexity: $O(n)$. Space Complexity: $O(1)$.

Problem-38 For a given K value ($K > 0$) reverse blocks of K nodes in a list.

Example: Input: 1 2 3 4 5 6 7 8 9 10. Output for different K values:

For $K = 2$: 2 1 4 3 6 5 8 7 10 9 For $K = 3$: 3 2 1 6 5 4 9 8 7 10 For $K = 4$: 4 3 2 1 8 7 6 5 9 10

Solution:

Algorithm: This is an extension of swapping nodes in a linked list.

- 1) Check if remaining list has K nodes.
 - a. If yes get the pointer of $K + 1$ th node.
 - b. Else return.
- 2) Reverse first K nodes.
- 3) Set next of last node (after reversal) to $K + 1$ th node.
- 4) Move to $K + 1$ th node.
- 5) Go to step 1.
- 6) $K - 1$ th node of first K nodes becomes the new head if available. Otherwise, we can return the head.

```

struct ListNode * GetKPlusOneThNode(int K, struct ListNode *head) {
    struct ListNode *Kth;
    int i = 0;
    if(!head)
        return head;
    for (i=0, Kth=head; Kth && (i < K); i++, Kth=Kth->next);
    if(i==K && Kth!=NULL)
        return Kth;
    return head->next;
}

int HasKnodes(struct ListNode *head, int K) {
    int i = 0;
    for(i=0; head && (i < K); i++, head=head->next);
    if(i == K)
        return 1;
    return 0;
}

struct ListNode *ReverseBlockOfK-nodesInLinkedList(struct ListNode *head, int K) {
    struct ListNode *cur=head, *temp, *next, newHead;
    int i;
    if(K==0 || K==1)
        return head;
    if(HasKnodes(cur, K-1))
        newHead = GetKPlusOneThNode(K-1, cur);
    else newHead = head;
    while(cur && HasKnodes(cur, K)) {
        temp = GetKPlusOneThNode(K, cur);
        i=0;
        while(i < K) {
            next = cur->next;
            cur->next=temp;
            temp = cur;
            cur = next;
            i++;
        }
    }
    return newHead;
}

```

Problem-39 Is it possible to get $O(1)$ access time for Linked Lists?

Solution: Yes. Create a linked list at the same time keep it in a hash table. For n elements we have to keep all the elements into hash table which gives preprocessing time of $O(n)$. To read any element we require only constant time $O(1)$ and to read n elements we require $n * 1$ unit of time = n units. Hence by using amortized analysis we can say that element access can be performed within $O(1)$ time.

Time Complexity – $O(1)$ [Amortized]. Space Complexity - $O(n)$ for Hash.

Problem-40 JosephusCircle: N people have decided to elect a leader by arranging themselves in a circle and eliminating every M^{th} person around the circle, closing ranks as each person drops out. Find which person will be the last one remaining (with rank 1).

Solution: Assume the input is a circular linked list with N nodes and each node has a number (range 1 to N) associated with it. The head node has number 1 as data.

```
struct ListNode *GetJosephusPosition(){
    struct ListNode *p, *q;
    printf("Enter N (number of players): "); scanf("%d", &N);
    printf("Enter M (every M-th payer gets eliminated): "); scanf("%d", &M);
    // Create circular linked list containing all the players:
    p = q = malloc(sizeof(struct node));
    p->data = 1;
    for (int i = 2; i <= N; ++i) {
        p->next = malloc(sizeof(struct node));
        p = p->next;
        p->data = i;
    }
    p->next = q; // Close the circular linked list by having the last node point to the first.
    // Eliminate every M-th player as long as more than one player remains:
    for (int count = N; count > 1; --count) {
        for (int i = 0; i < M - 1; ++i)
            p = p->next;
        p->next = p->next->next; // Remove the eliminated player from the circular linked list.
    }
    printf("Last player left standing (Josephus Position) is %d\n.", p->data);
}
```

Problem-41 Given a linked list consists of data, next pointer and also a random pointer which points to a random node of the list. Give an algorithm for cloning the list.

Solution: We can use the hash table to associate newly created nodes with the instances of node in the given list.

Algorithm:

- Scan the original list and for each node X , create a new node Y with data of X , then store the pair (X, Y) in hash table using X as a key. Note that during this scan we set $Y \rightarrow next$ and $Y \rightarrow random$ to $NULL$ and we will fix them in the next scan
- Now for each node X in the original list we have a copy Y stored in our hash table. We scan again the original list and set the pointers building the new list

```
struct ListNode *Clone(struct ListNode *head){
    struct ListNode *X, *Y;
    struct HashTable *HT = CreateHashTable();
    X = head;
    while (X != NULL) {
        Y = (struct ListNode *)malloc(sizeof(struct ListNode *));
        Y->data = X->data;
```

```

        Y->next = NULL;
        Y->random = NULL;
        HT.insert(X, Y);
        X = X->next;
    }
    X = head;
    while (X != NULL) {
        // get the node Y corresponding to X from the hash table
        Y = HT.get(X);
        Y->next = HT.get(X->next);
        Y->random = HT.get(X->random);
        X = X->next;
    }
    // Return the head of the new list, that is the Node Y
    return HT.get(head);
}

```

Time Complexity: $O(n)$. Space Complexity: $O(n)$.

Problem-42 Can we solve Problem-41 without any extra space?

Solution: Yes. Follow the comments in below code and traceout.

```

void Clone(struct ListNode *head){
    struct ListNode *temp, *temp2;
    //Step1: put temp->random in temp2->next, so that we can reuse the temp->random field to point to temp2.
    temp = head;
    while (temp != NULL) {
        temp2 = (struct ListNode *)malloc(sizeof(struct ListNode *));
        temp2->data = temp->data;
        temp2->next = temp->random;
        temp->random = temp2;
        temp = temp->next;
    }
    //Step2: Setting temp2->random. temp2->next is the old copy of the node that
    // temp2->random should point to, so temp2->next->random is the new copy.
    temp = head;
    while (temp != NULL) {
        temp2 = temp->random;
        temp2->random = temp2->next->random;
        temp = temp->next;
    }
    //Step3: Repair damage to old list and fill in next pointer in new list.
    temp = head;
    while (temp != NULL) {
        temp2 = temp->random;
        temp->random = temp2->next;
        temp2->next = temp->next->random;
        temp = temp->next;
    }
}

```

Time Complexity: $O(3n) \approx O(n)$. Space Complexity: $O(1)$.